

Přehled modelů SEAT

Název modelu	Cyklus modelů	Název modelů	Cyklus modelu
A		L	
Altea BiFuel	od 2009	Leon ST	od 2014
Altea	od 2004	Leon 3 - dveřový	od 2013
Altea XL BiFuel	od 2009	Leon 5 - dveřový	od 2013
Altea XL	od 2007	Leon BiFue	od 2009
		Leon	od 2006
Alhambra	od 2011	Leon	1999-2006
Alhambra	od 2016	Leon 5 - dveřový TGI	od 2013
Alhambra	2001-2010	Leon 5 - dveřový ST TGI	od 2014
		Leon ST Xperience	od 2014
Ateca	od 2017		
C		M	
Cordoba	2003-2009	Mii 3 - dveřová	od 2012
		Mii 3 - dveřová Ecofuel	od 2012
		Mii 5 - dveřová	od 2012
		Mii 5 - dveřová Ecofuel	od 2012
E		T	
Exeo	od 2009	Toledo	2005-2009
Exeo ST	od 2010	Toledo	od 2013
		Toledo	1999-2004
		Toledo baterie v zavazadlovém prostoru	od 2013
I			
Ibiza 3 - dveřová	2009-2015		
Ibiza 3 - dveřová baterie v zavazadlovém prostoru	od 2009		
Ibiza 3 - dveřová BiFuel	od 2012		
Ibiza 3 - dveřová	od 2016		
Ibiza 5 - dveřová	2009-2015		
Ibiza 3 - dveřová	od 2016		
Ibiza 5 - dveřová baterie v zavazadlovém prostoru	od 2009		
Ibiza 3 - dveřová	2002-2009		
Ibiza 5 - dveřová	2002-2009		
Ibiza 5 - dveřová	od 2016		
Ibiza 5 - dveřová BiFuel	od 2012		
Ibiza ST	2011-2015		
Ibiza ST	od 2016		

Altea

(BiFuel, od 2009)

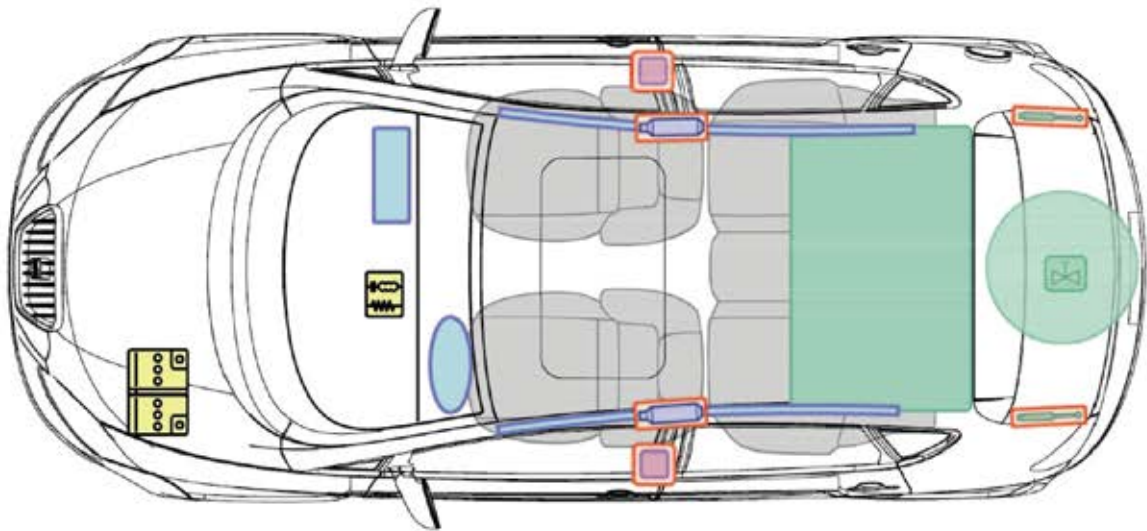



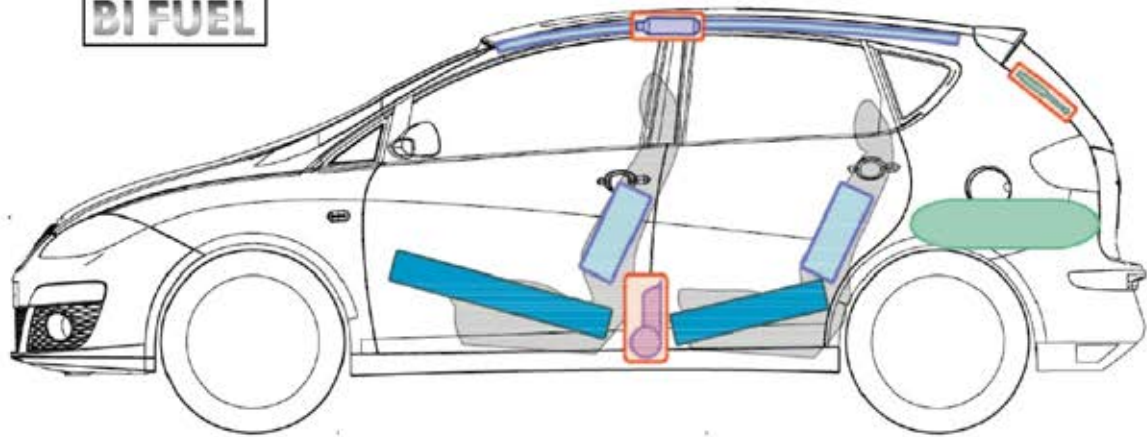

BI FUEL



A

Legenda

	airbag		zesílení karoserie		řídící jednotka pro airbag
	plynový generátor		ochrana proti převrácení		baterie
	napínač bezpečnostních pásů		plyno-kapalinové vzpěry		nádrž na pohonné hmoty
	plynová nádrž		bezpečnostní ventil		

Altea (BiFuel)

Altea



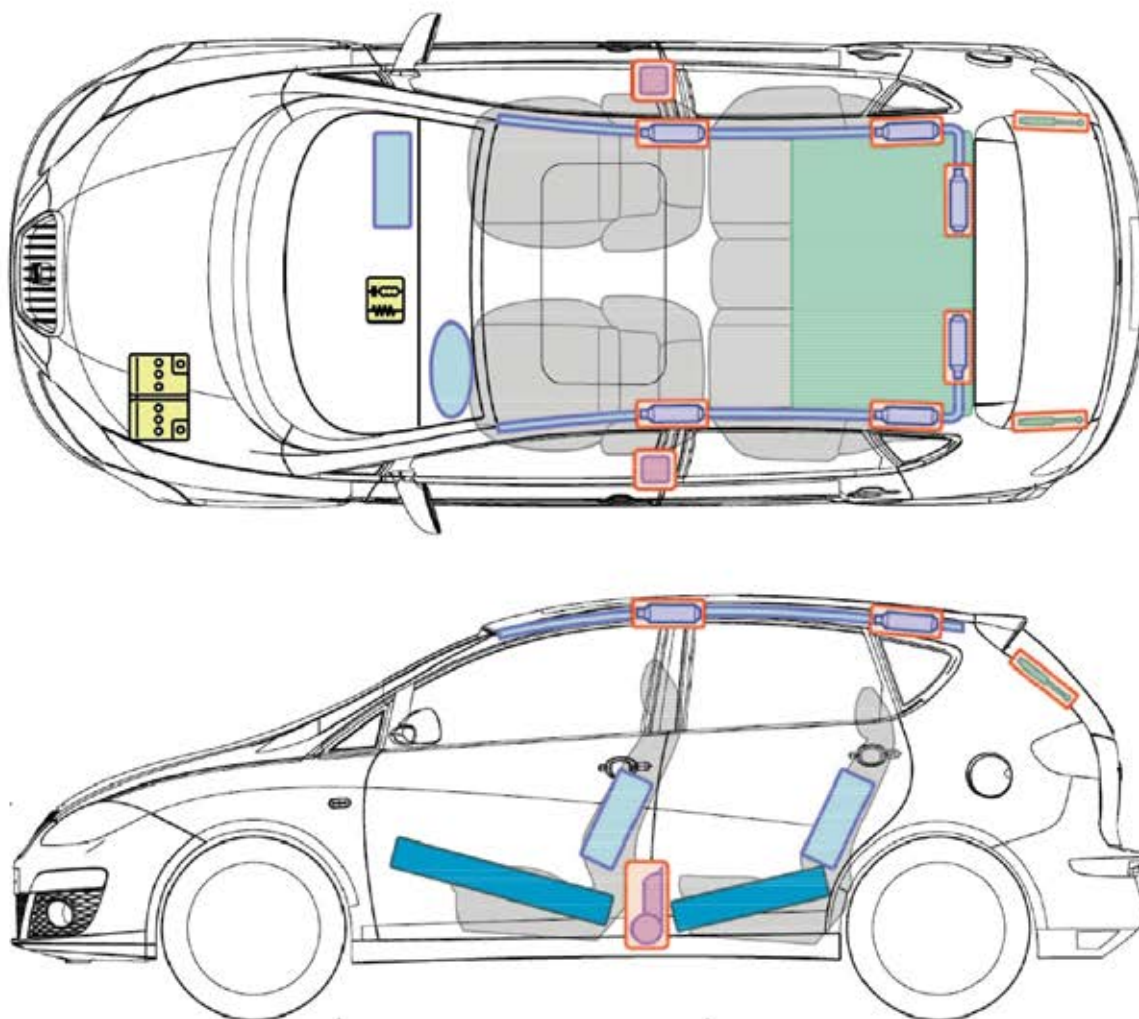





(od 2004)



A

Altea

Legenda

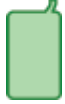
	airbag		zesílení karoserie		řídící jednotka pro airbag
	plynový generátor		ochrana proti převrácení		baterie
	napínač bezpečnostních pásů		plyno-kapalinové vzpěry		nádrž na pohonné hmoty

Altea XL

(BiFuel, od 2009)

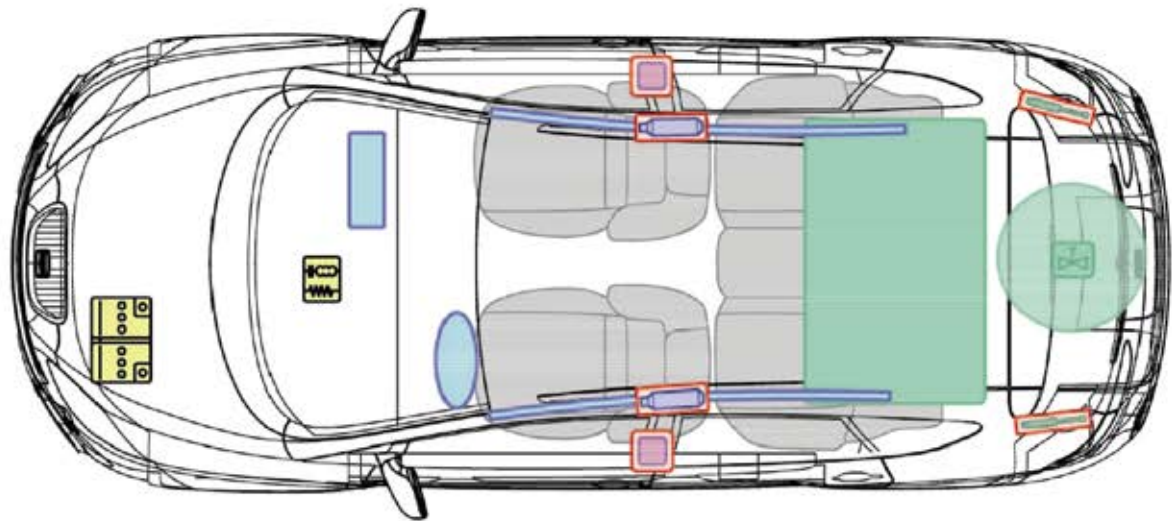



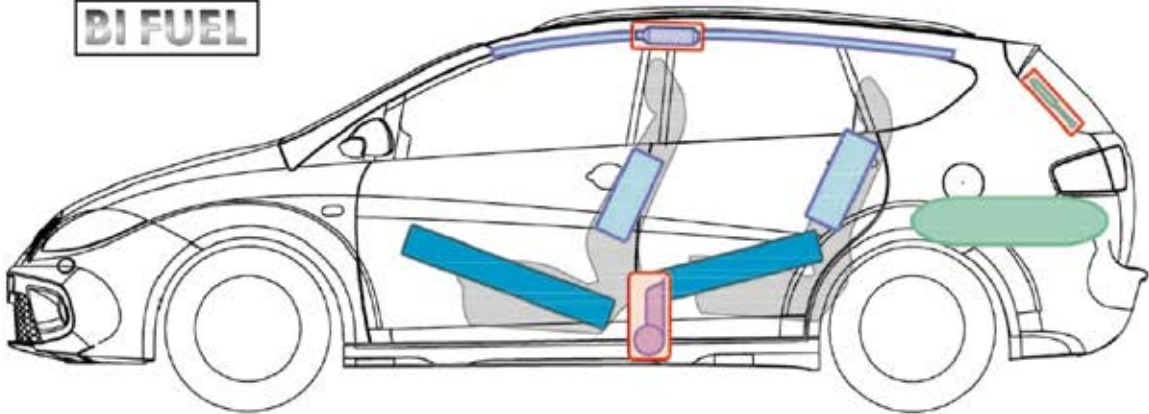





BI FUEL

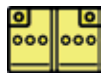

A

Legenda

	airbag		zesílení karoserie		řídící jednotka pro airbag
	plynový generátor		ochrana proti převrácení		baterie
	napínač bezpečnostních pásů		plyno-kapalinové vzpěry		nádrž na pohonné hmoty
	plynová nádrž		bezpečnostní ventil		

Altea XL (BiFuel)

Altea XL



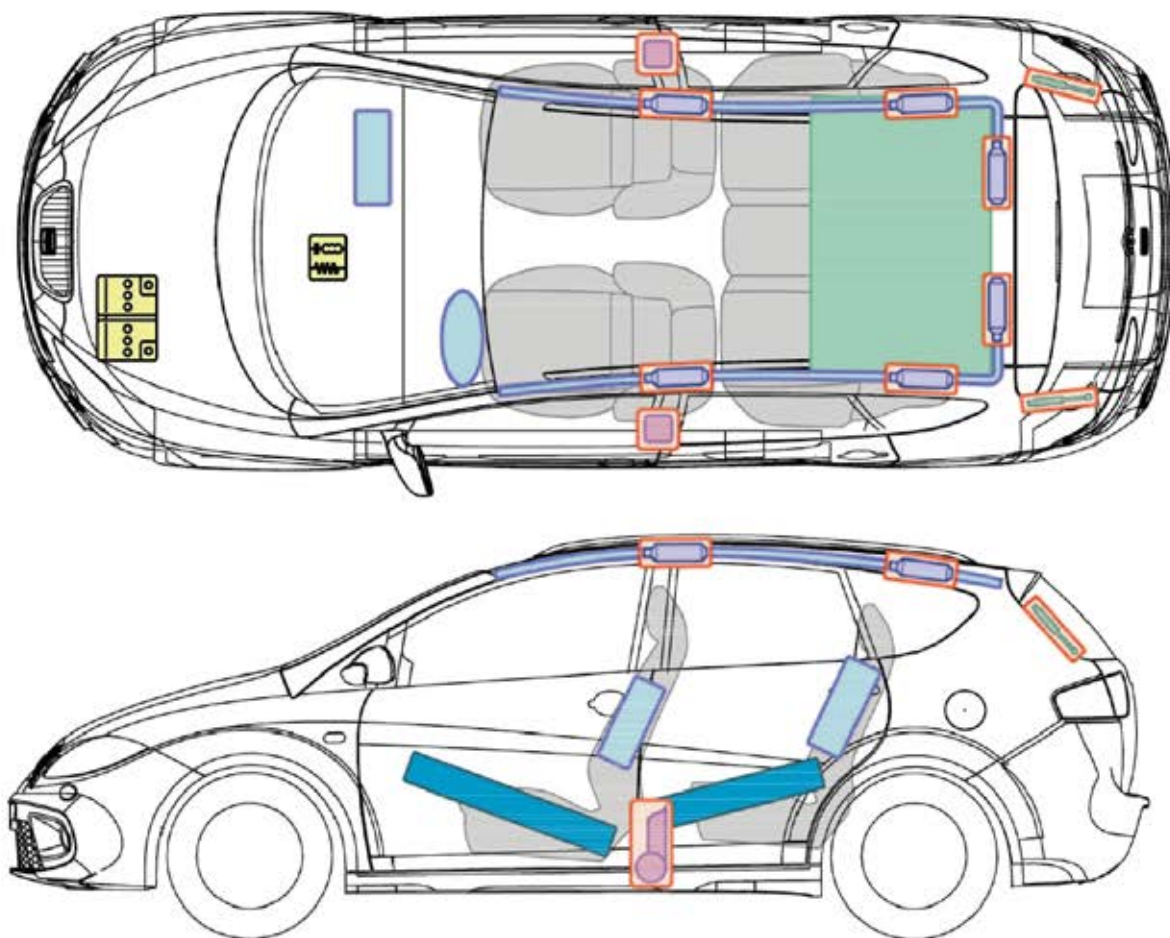



(od 2007)



A

Altea XL

Legenda

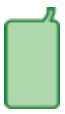
 airbag	 zesílení karoserie	 řídicí jednotka pro airbag
 plynový generátor	 ochrana proti převrácení	 baterie
 napínač bezpečnostních pásů	 plyno-kapalinové vzpěry	 nádrž na pohonné hmoty

Alhambra



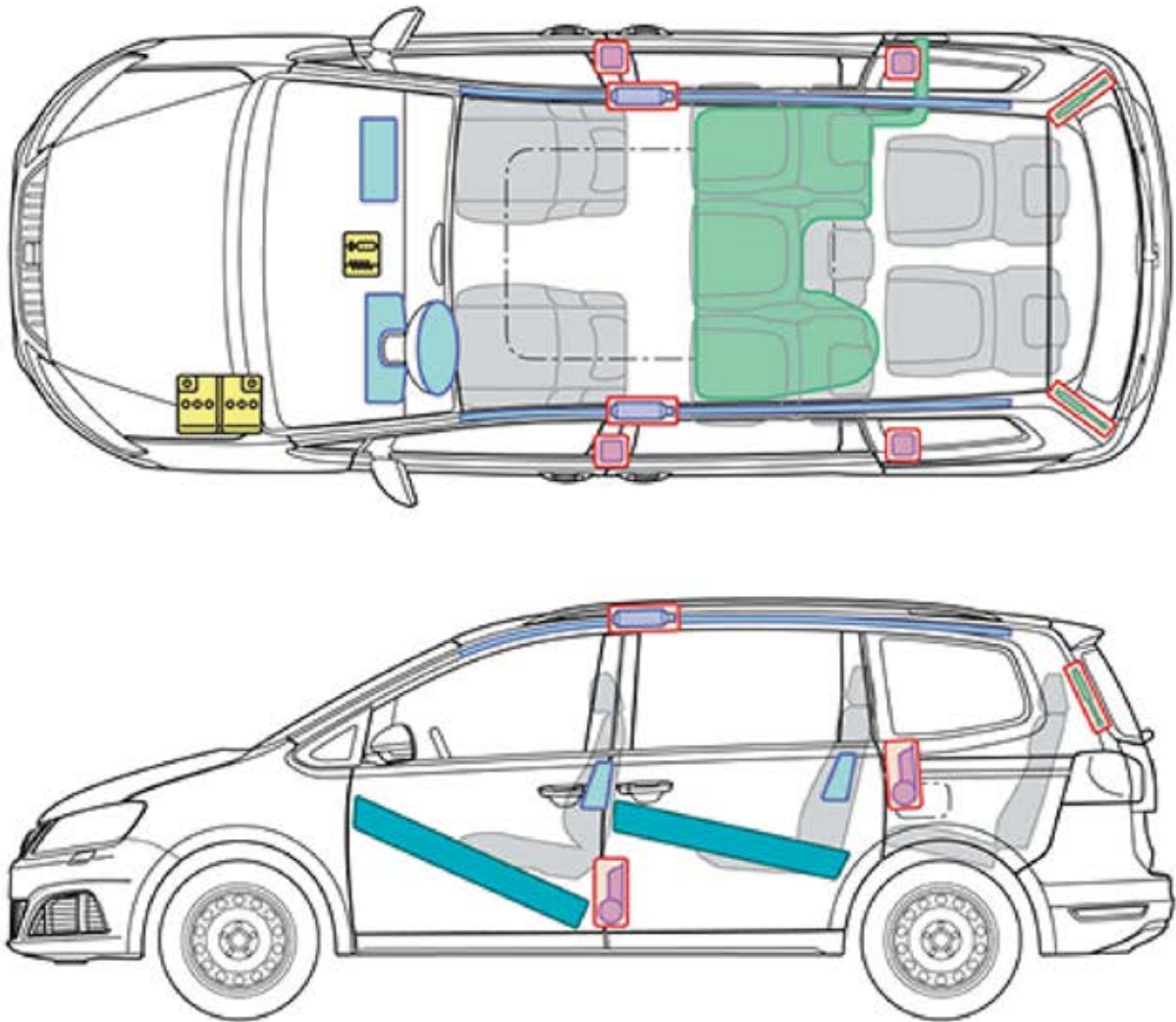





(od 2011)



A

Alhambra

Legenda

	airbag		zesílení karoserie		řídící jednotka pro airbag
	plynový generátor				baterie
	napínač bezpečnostních pásů		plyno-kapalinové vzpěry		nádrž na pohonné hmoty

Alhambra

(2001–2010)



v závislosti na výbavě - přídavná baterie pod sedadlem spolujezdce

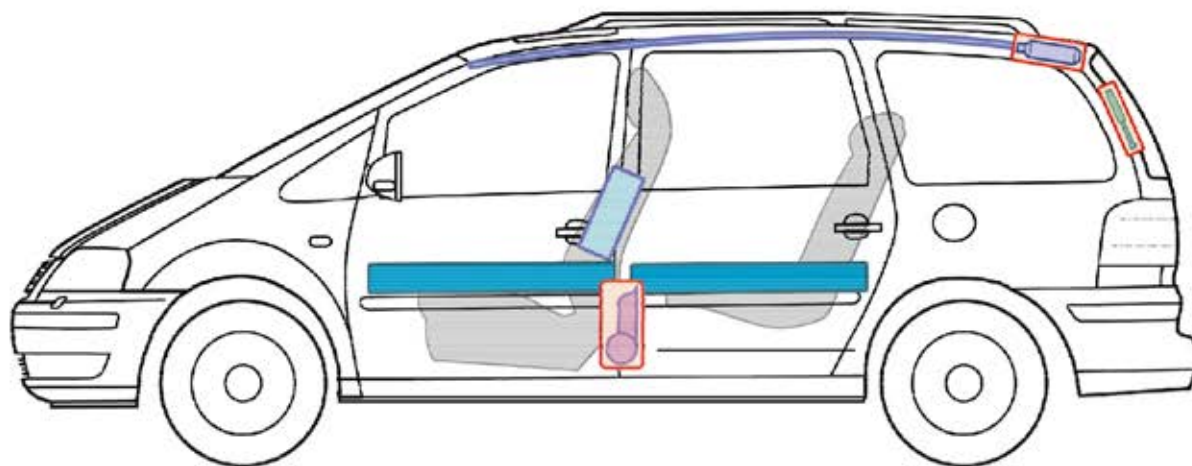
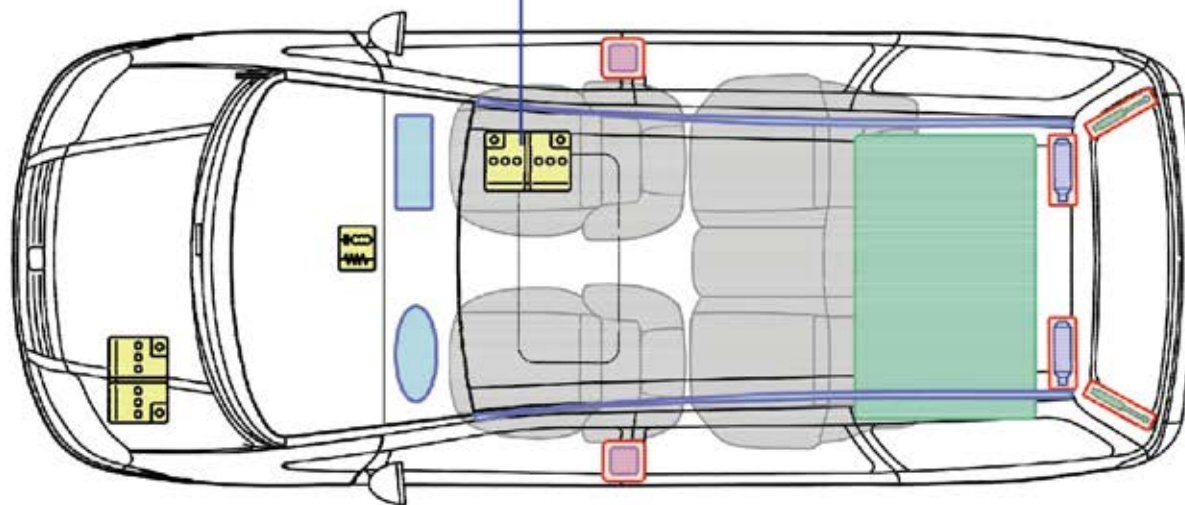

A

Alhambra

Legenda

	airbag		zesílení karoserie		řídící jednotka pro airbag
	plynový generátor				baterie
	napínač bezpečnostních pásů		plyno-kapalinové vzpěry		nádrž na pohonné hmoty

Alhambra (od 2016)

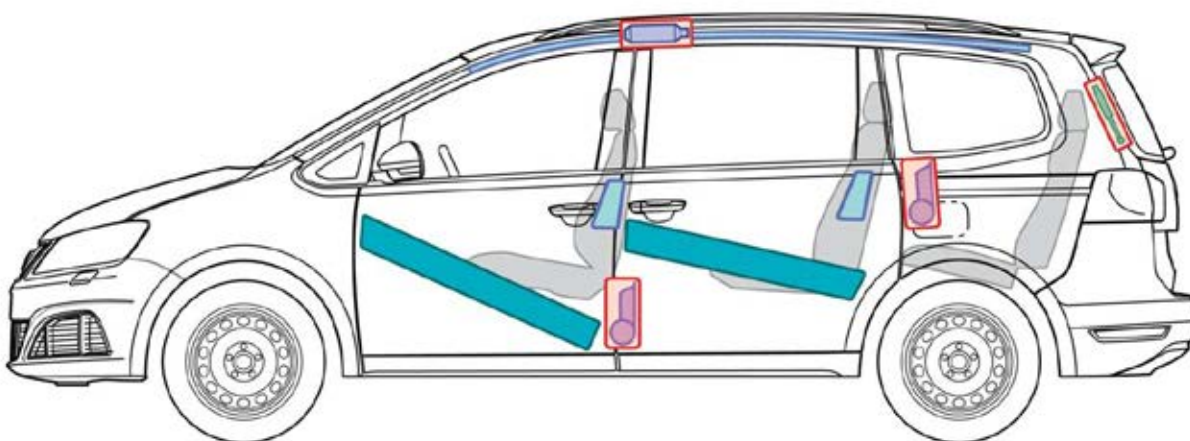
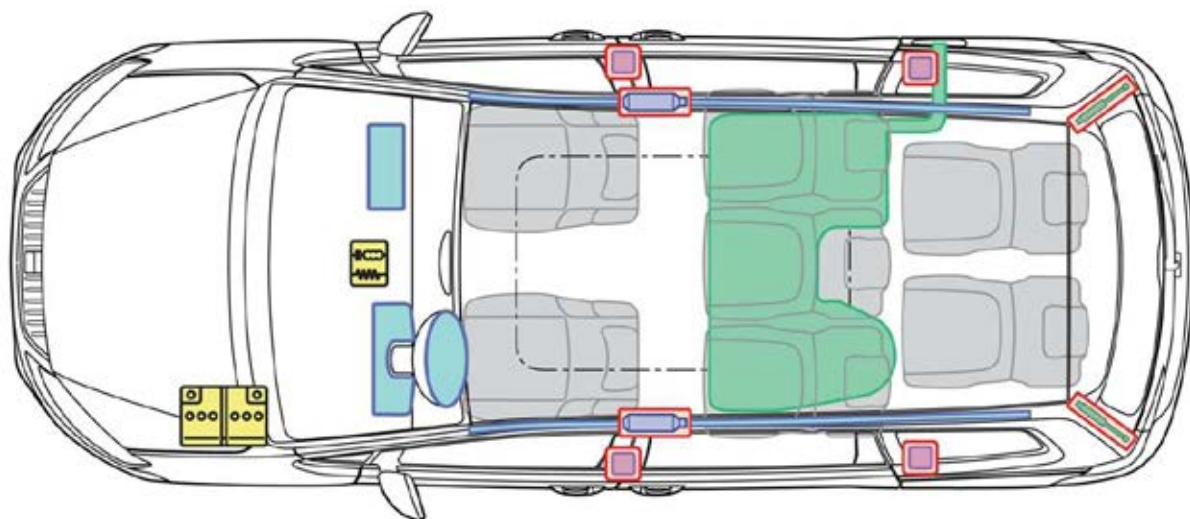

A

Legenda

	airbag		zesílení karoserie		řídící jednotka pro airbag
	plynový generátor				baterie
	napínač bezpečnostních pásů		plyno-kapalinové vzpěry		nádrž na pohonné hmoty

Alhambra

Ateca



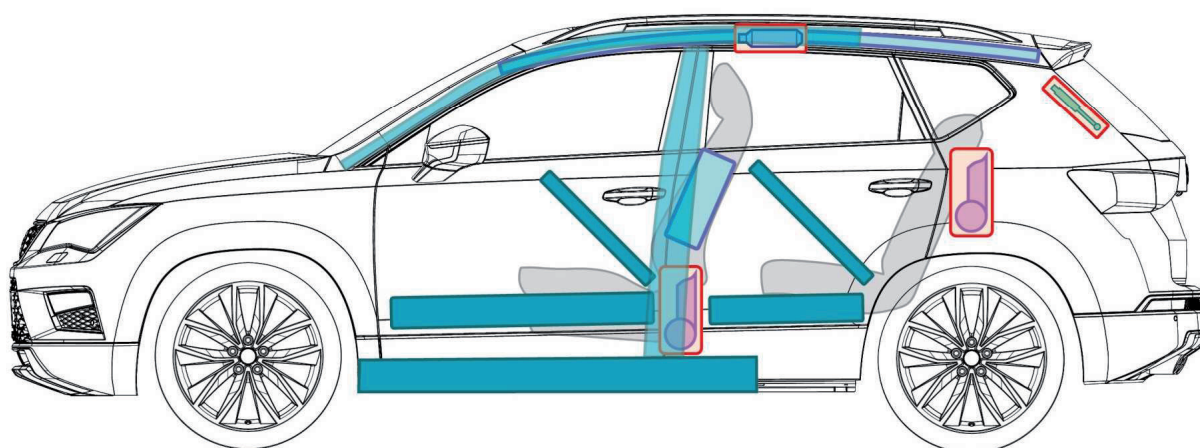
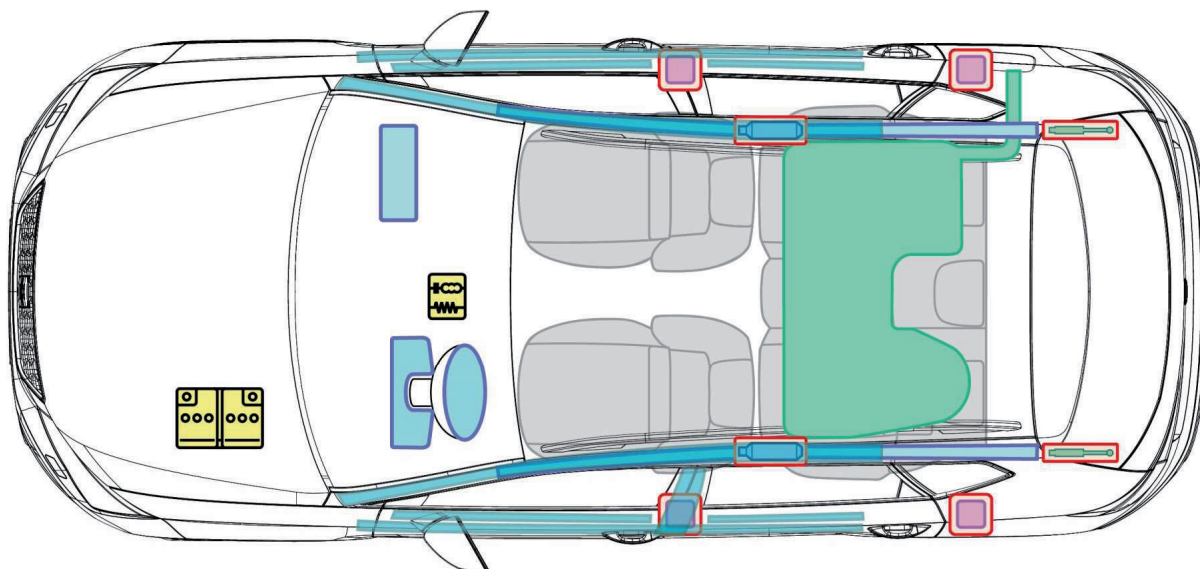





(od 2017)



A

Ateca

Legenda

	airbag		zesílení karoserie		řídící jednotka pro airbag
	plynový generátor		nádrž na pohonné hmoty		baterie
	napínač bezpečnostních pásů		plyno- kapalinové vzpěry		

Cordoba



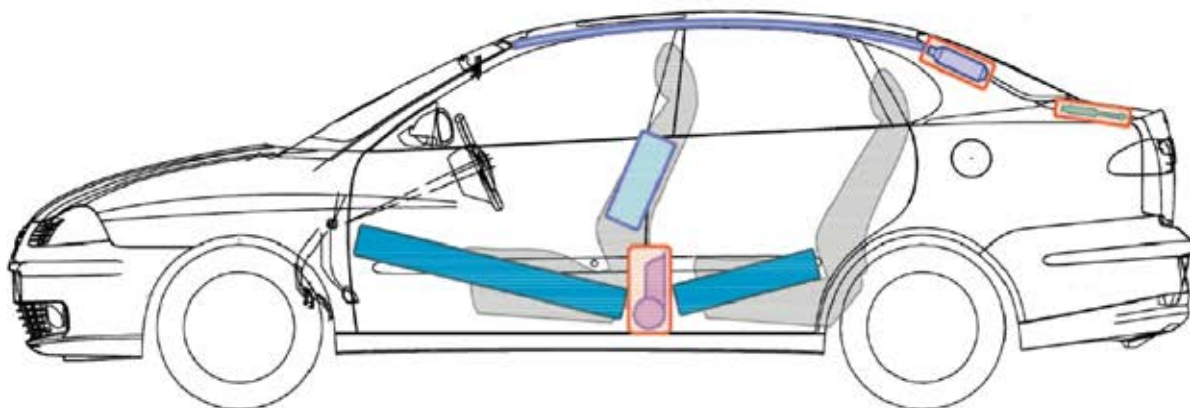
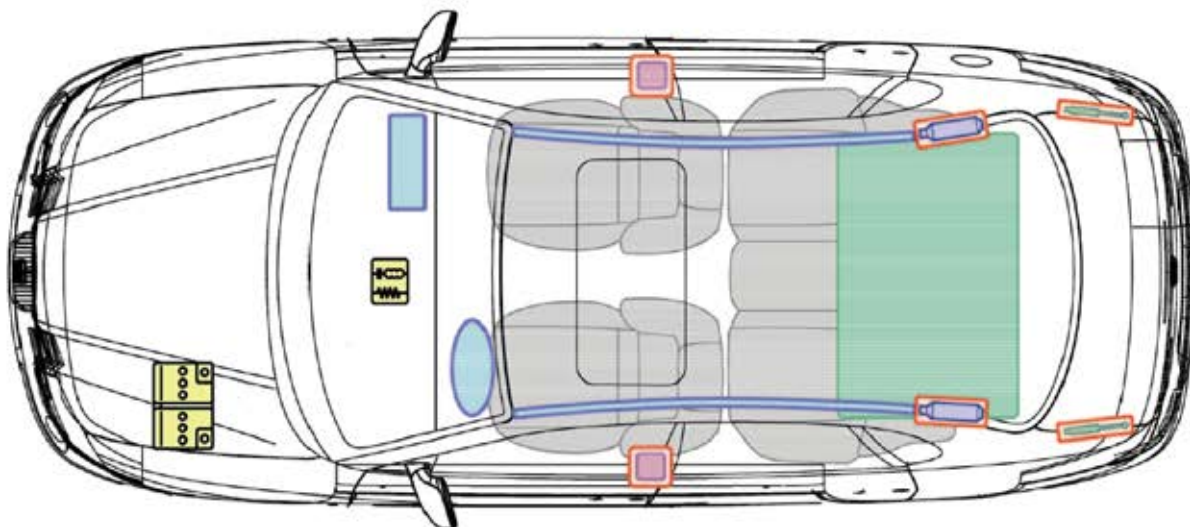





(2003–2009)

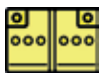

C

Cordoba

Legenda

	airbag		zesílení karoserie		řídící jednotka pro airbag
	plynový generátor		ochrana proti převrácení		baterie
	napínač bezpečnostních pásů		plyno-kapalinové vzpěry		nádrž na pohonné hmoty





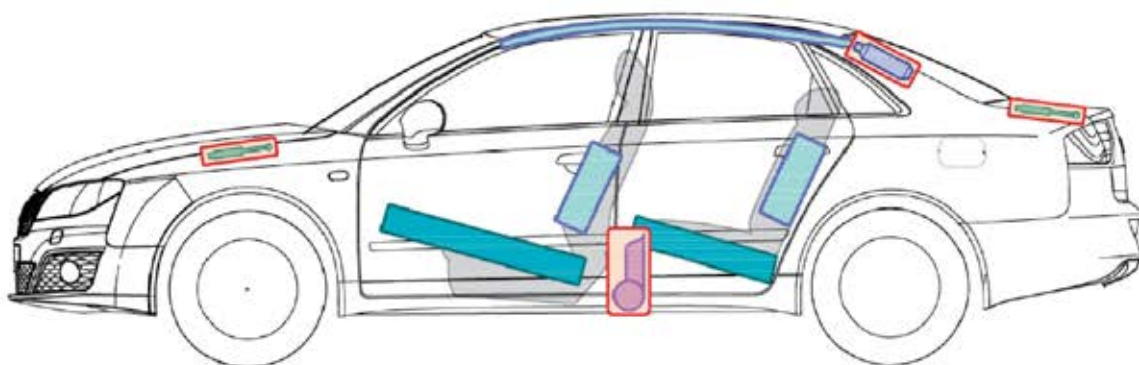
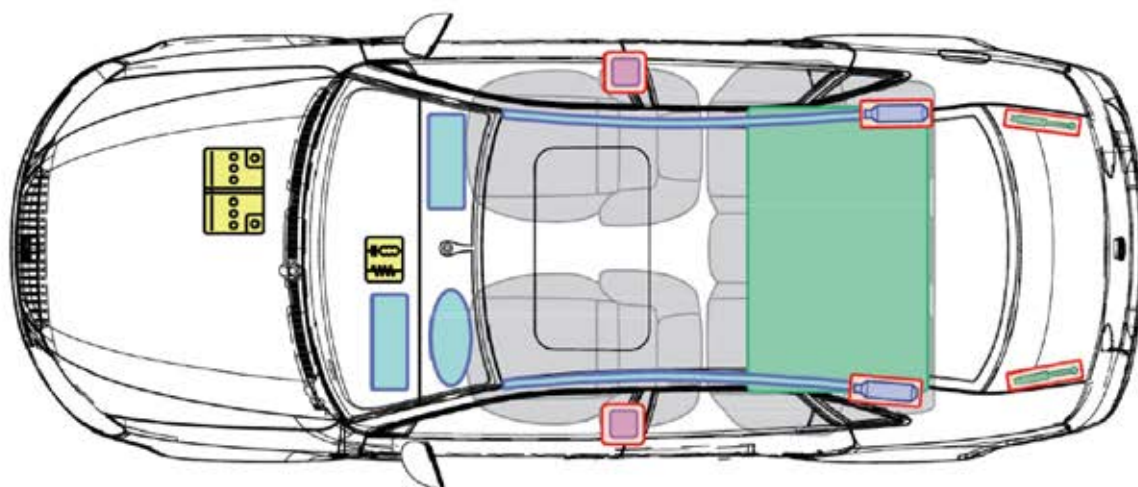



Exeo

(od 2009)

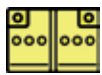

Exeo

Legenda

	airbag		zesílení karoserie		řídící jednotka pro airbag
	plynový generátor		ochrana proti převrácení		baterie
	napínač bezpečnostních pásů		plyno-kapalinové vzpěry		nádrž na pohonné hmoty

Exeo ST



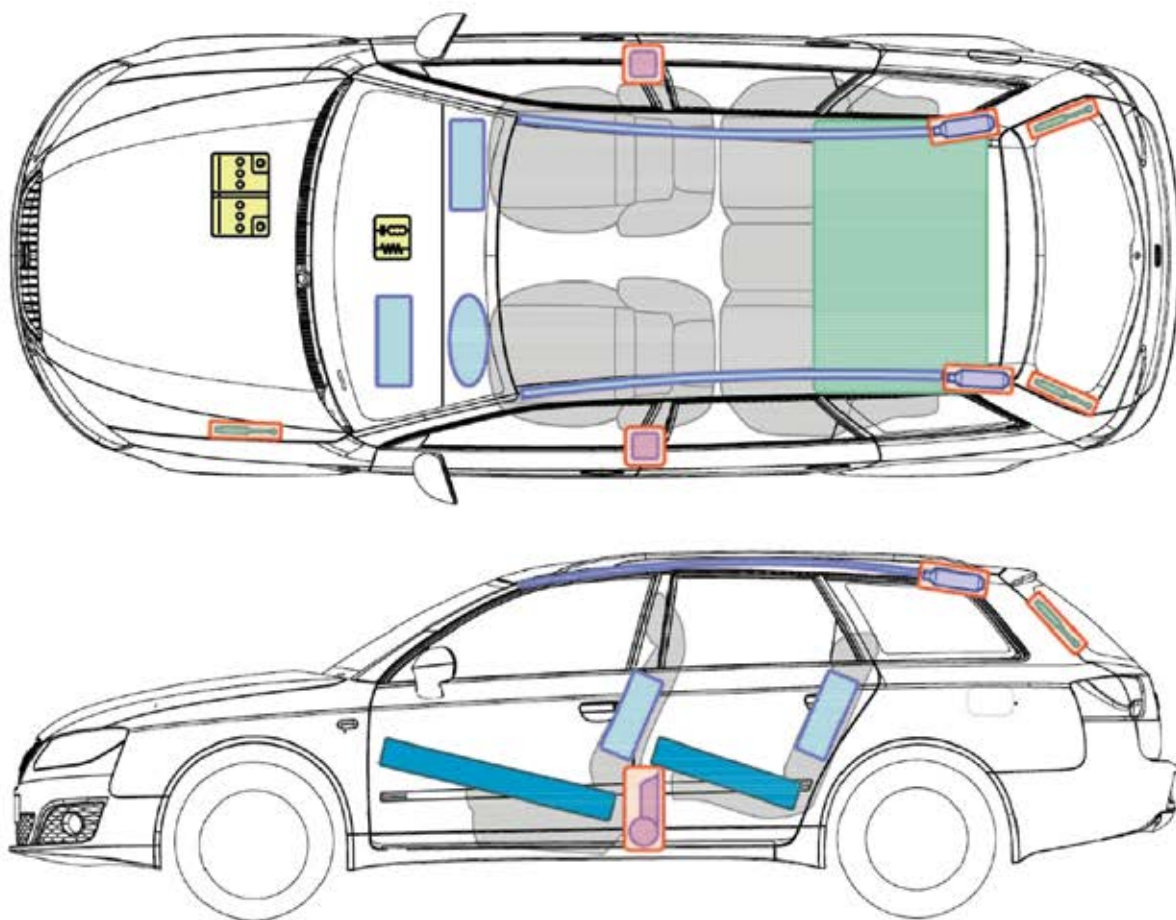





(od 2010)



SEAT

Exeo ST

Legenda



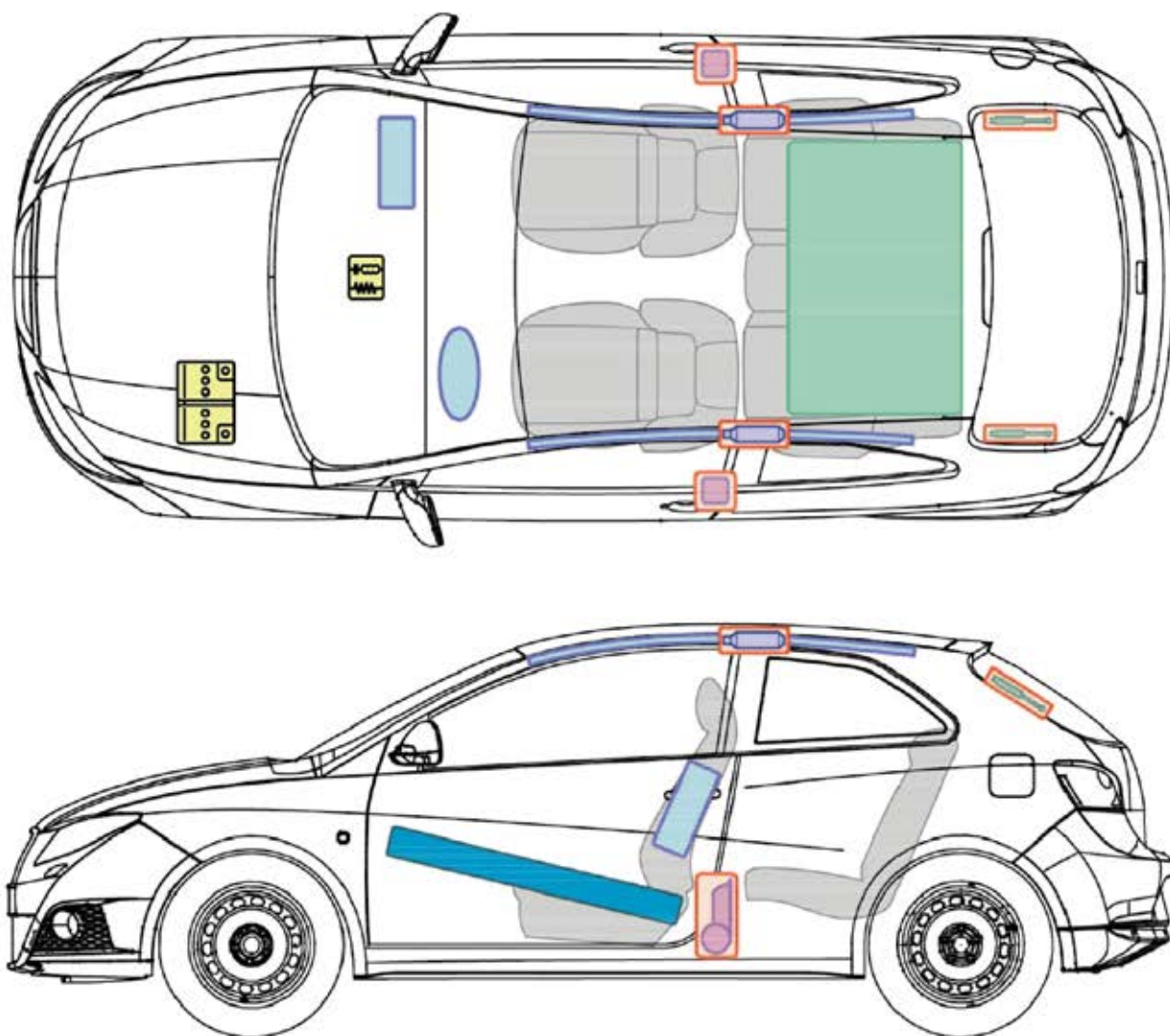

 airbag	 zesílení karoserie	 řídicí jednotka pro airbag
 plynový generátor	 ochrana proti převrácení	 baterie
 napínač bezpečnostních pásů	 plyno-kapalinové vzpěry	 nádrž na pohonné hmoty

Ibiza

(3 - dveřová, od 2009–2015)

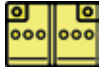

Legenda

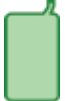
	airbag		zesílení karoserie		řídící jednotka pro airbag
	plynový generátor		ochrana proti převrácení		baterie
	napínač bezpečnostních pásů		plyno-kapalinové vzpěry		nádrž na pohonné hmoty



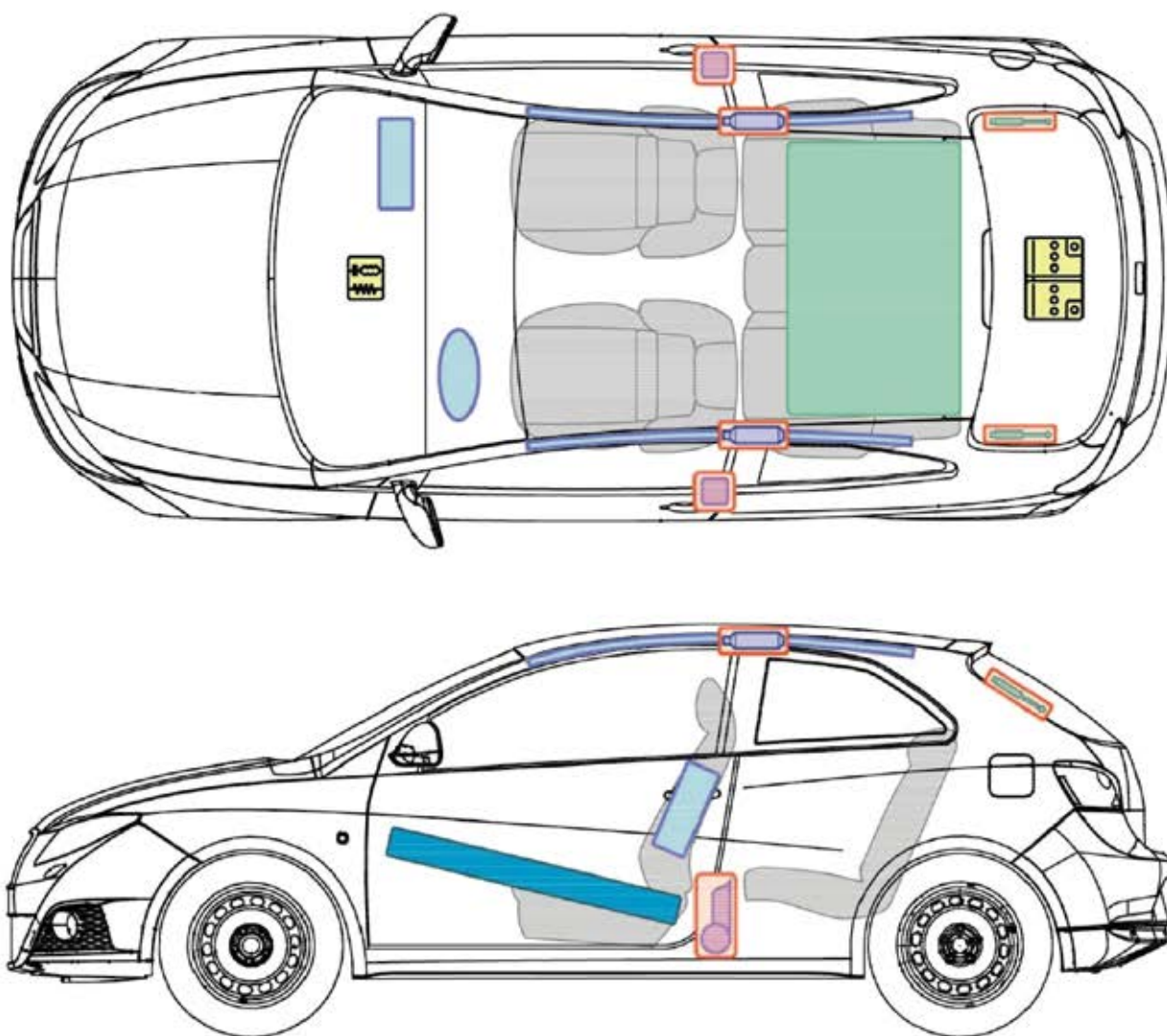

Ibiza (3 - dveřová)

Ibiza

(3 - dveřová, od 2009)
baterie v zavazadlovém
prostoru

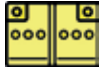

Legenda

	airbag		zesílení karoserie		řídící jednotka pro airbag
	plynový generátor		ochrana proti převrácení		baterie
	napínač bezpečnostních pásů		plyno-kapalinové vzpěry		nádrž na pohonné hmoty

Ibiza (3 - dveřová)

Ibiza

(BiFuel, 3 - dveřová, od 2012)

Motor CNKA 1,6L (LPG)

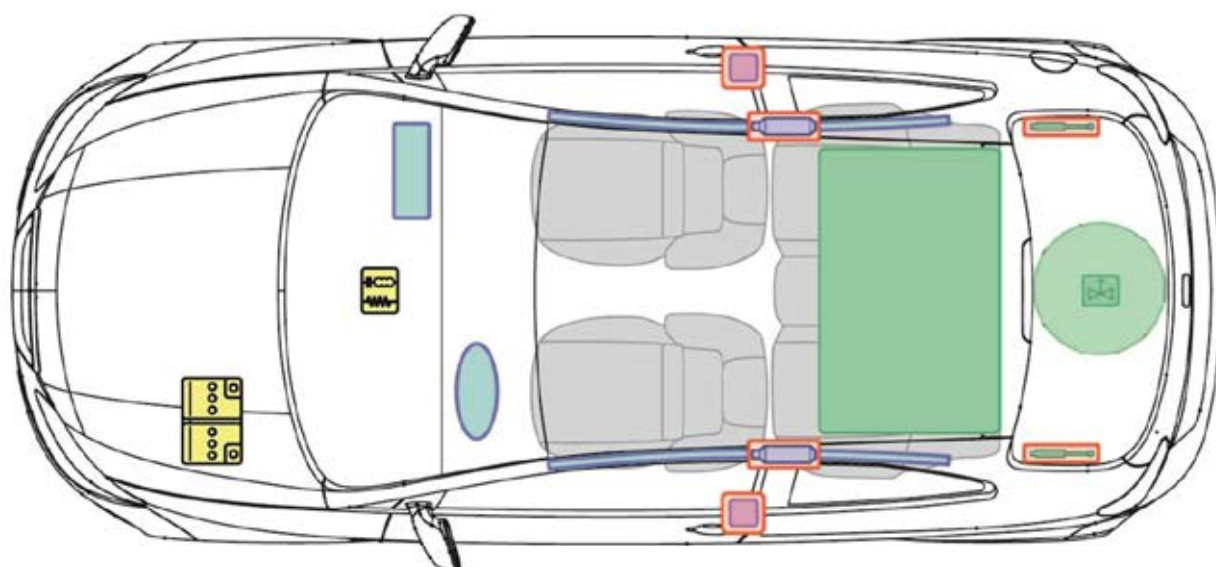

BI FUEL

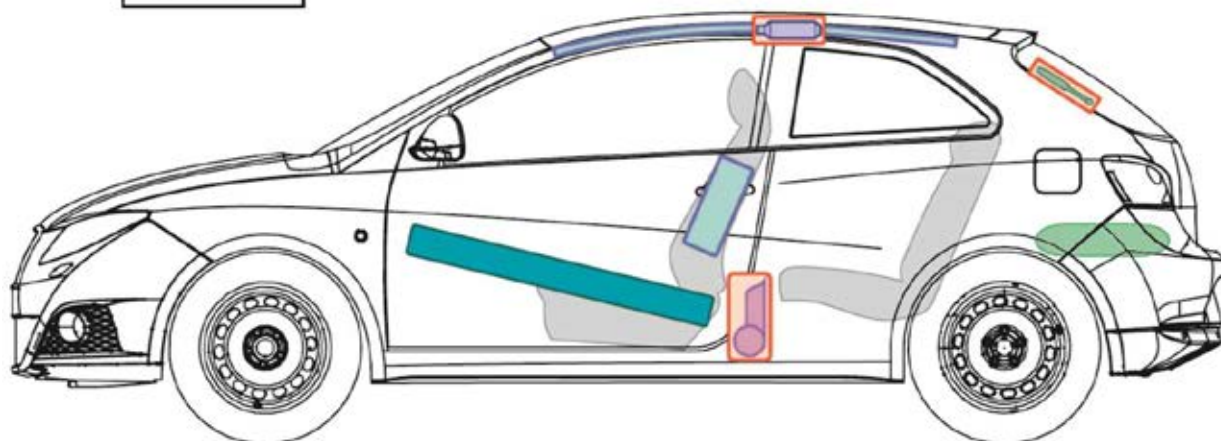

Legenda

	airbag		zesílení karoserie		řídící jednotka pro airbag
	plynový generátor		ochrana proti převrácení		baterie
	napínač bezpečnostních pásů		plyno-kapalinové vzpěry		nádrž na pohonné hmoty
	plynová nádrž		bezpečnostní ventil		

Ibiza (BiFuel, 3 - dveřová)

Ibiza

(3 - dveřová, od 2016)

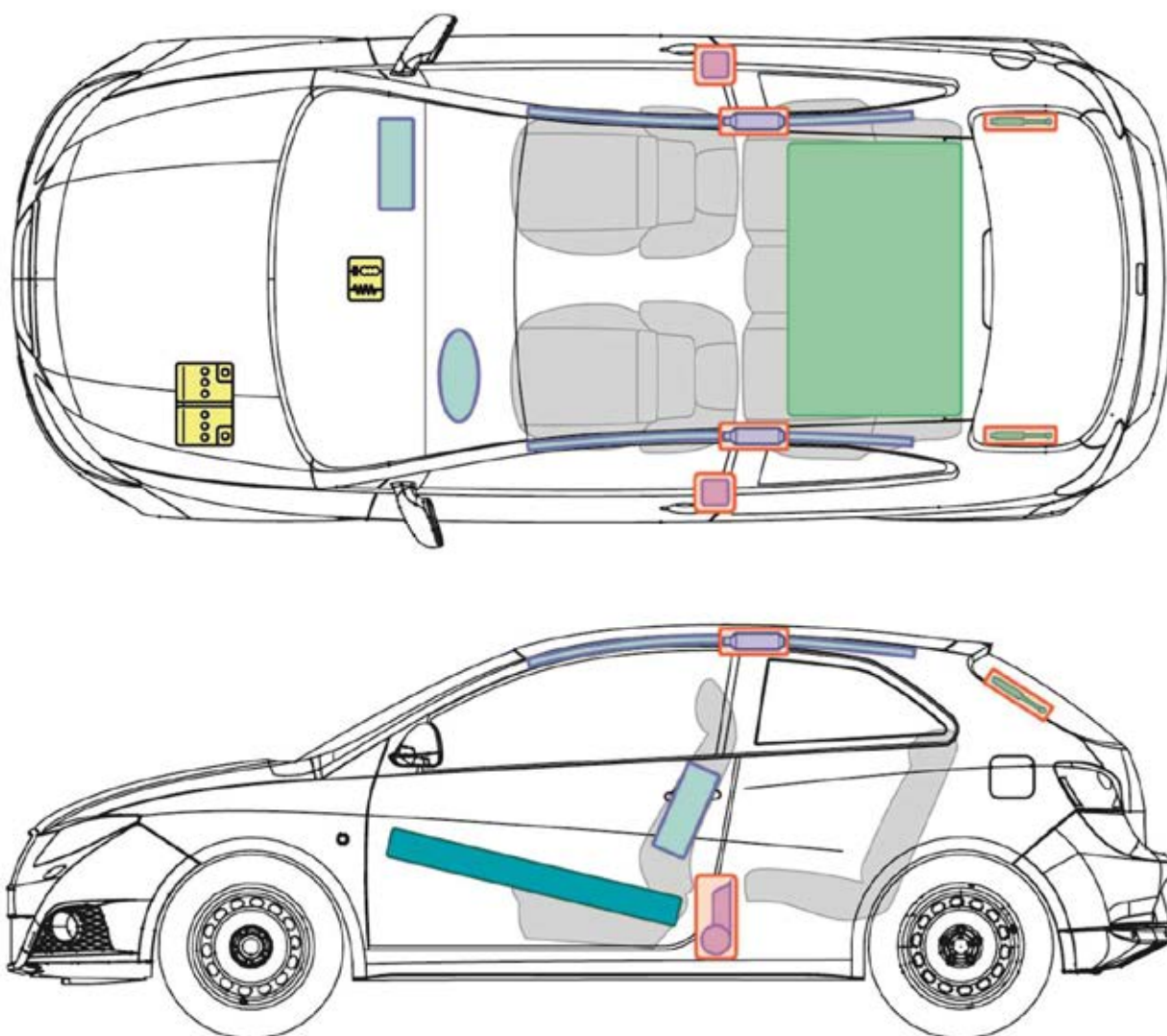

Legenda

	airbag		zesílení karoserie		řídící jednotka pro airbag
	plynový generátor		ochrana proti převrácení		baterie
	napínač bezpečnostních pásů		plyno-kapalinové vzpěry		nádrž na pohonné hmoty







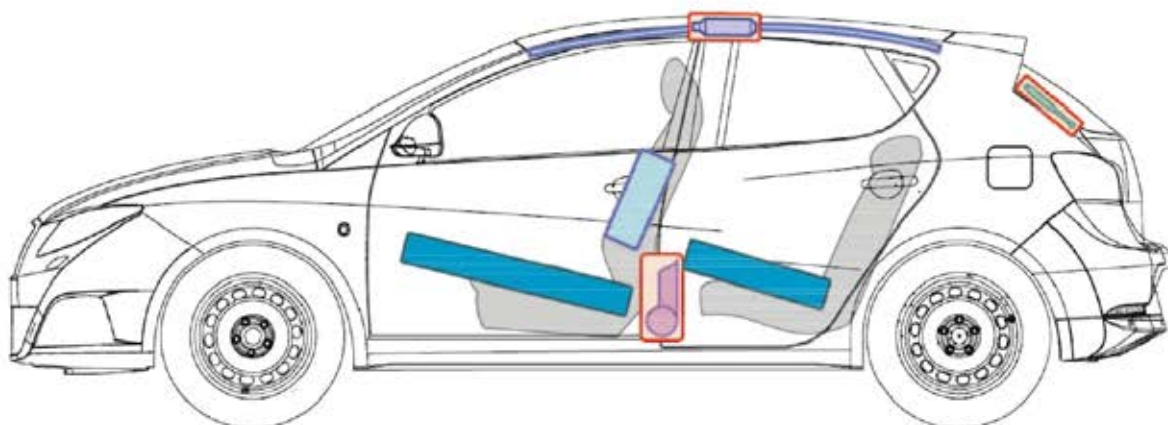
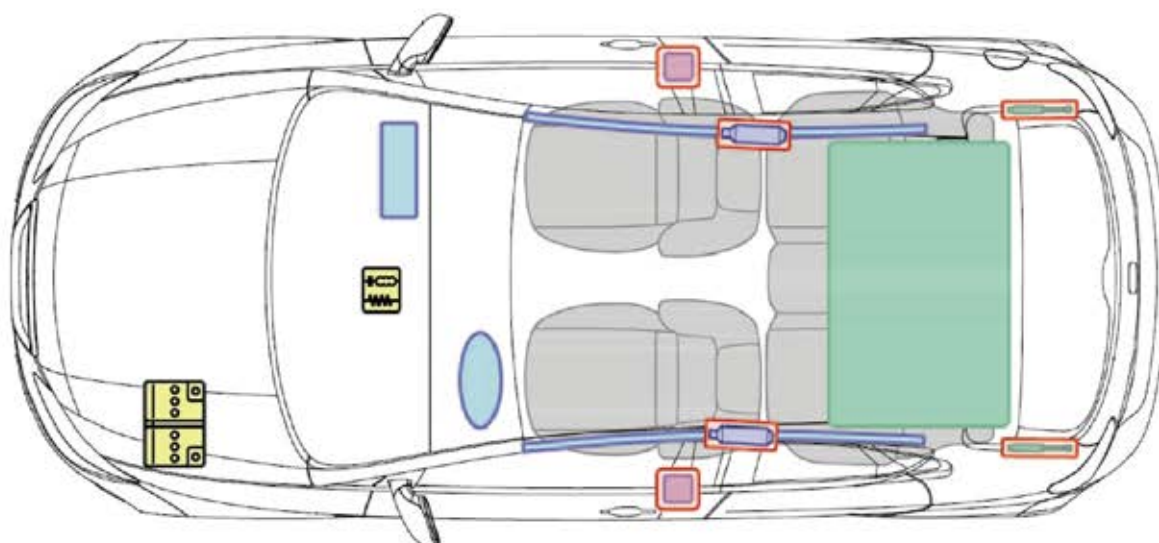

Ibiza (3 - dveřová)

Ibiza

(5 - dveřová, od 2009–2015)

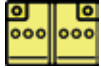

Legenda

	airbag		zesílení karoserie		řídící jednotka pro airbag
	plynový generátor		ochrana proti převrácení		baterie
	napínač bezpečnostních pásů		plyno-kapalinové vzpěry		nádrž na pohonné hmoty

Ibiza (5 - dveřová)

Ibiza

(3 - dveřová, od 2016)

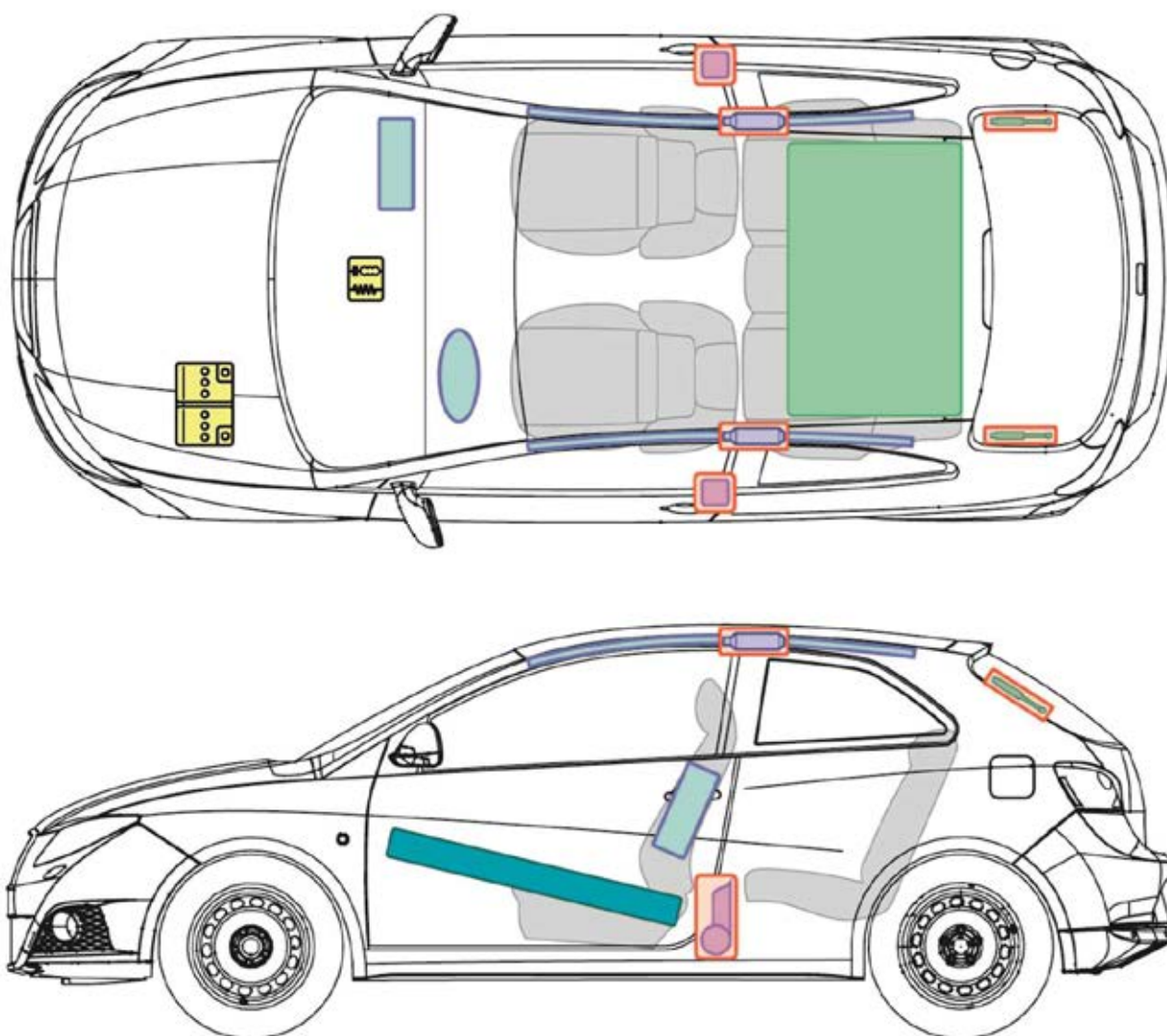

Legenda

	airbag		zesílení karoserie		řídící jednotka pro airbag
	plynový generátor		ochrana proti převrácení		baterie
	napínač bezpečnostních pásů		plyno-kapalinové vzpěry		nádrž na pohonné hmoty



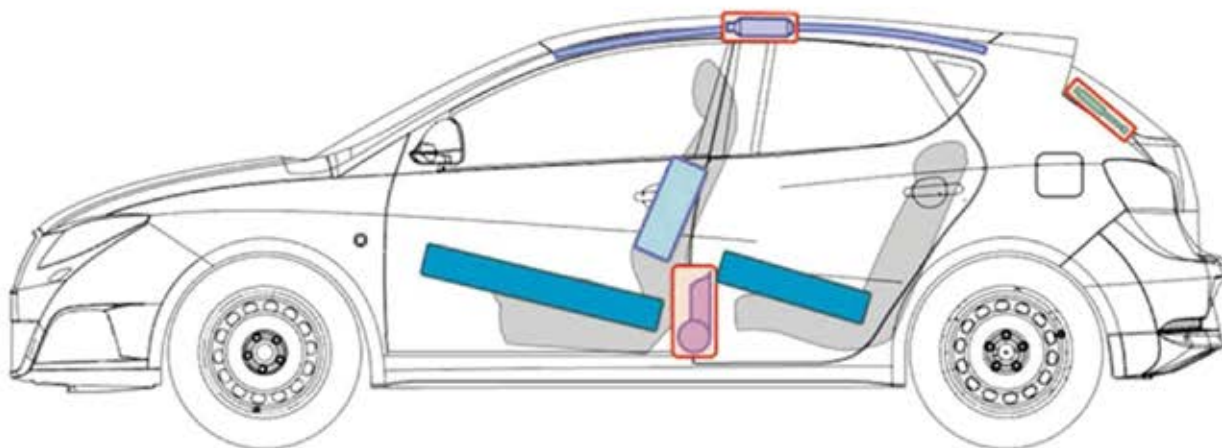
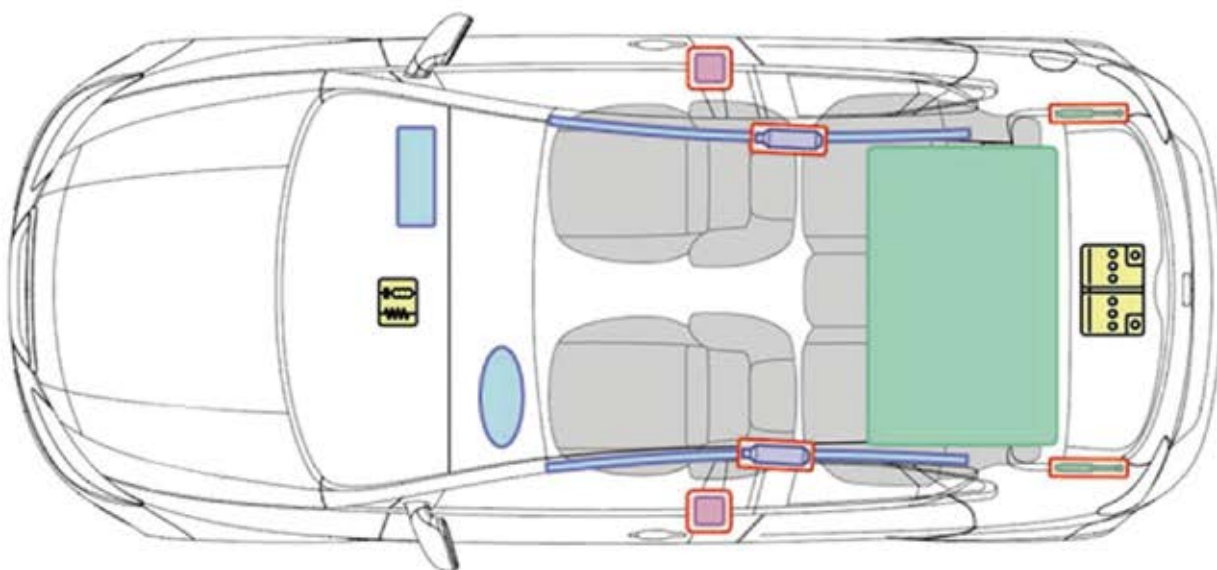

Ibiza (3 - dveřová)

Ibiza

(5 - dveřová, od 2009)
baterie v zavazadlovém
prostoru

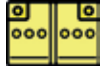

Legenda

	airbag		zesílení karoserie		řídící jednotka pro airbag
	plynový generátor		ochrana proti převrácení		baterie
	napínač bezpečnostních pásů		plyno-kapalinové vzpěry		nádrž na pohonné hmoty



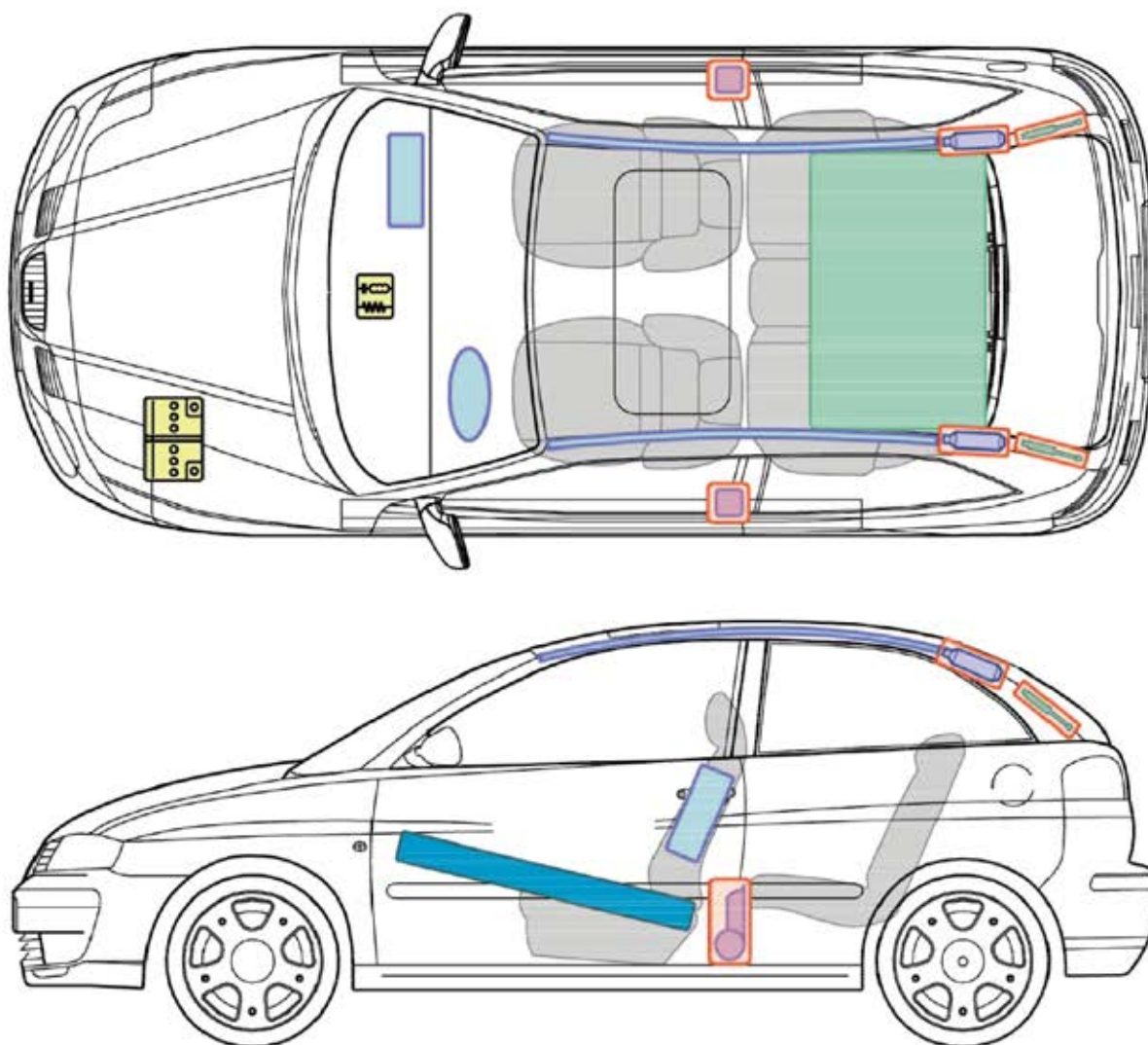

Ibiza (5 - dveřová)

Ibiza

(3 - dveřová, 2002–2009)



Legenda

	airbag		zesílení karoserie		řídící jednotka pro airbag
	plynový generátor		ochrana proti převrácení		baterie
	napínač bezpečnostních pásů		plyno-kapalinové vzpěry		nádrž na pohonné hmoty





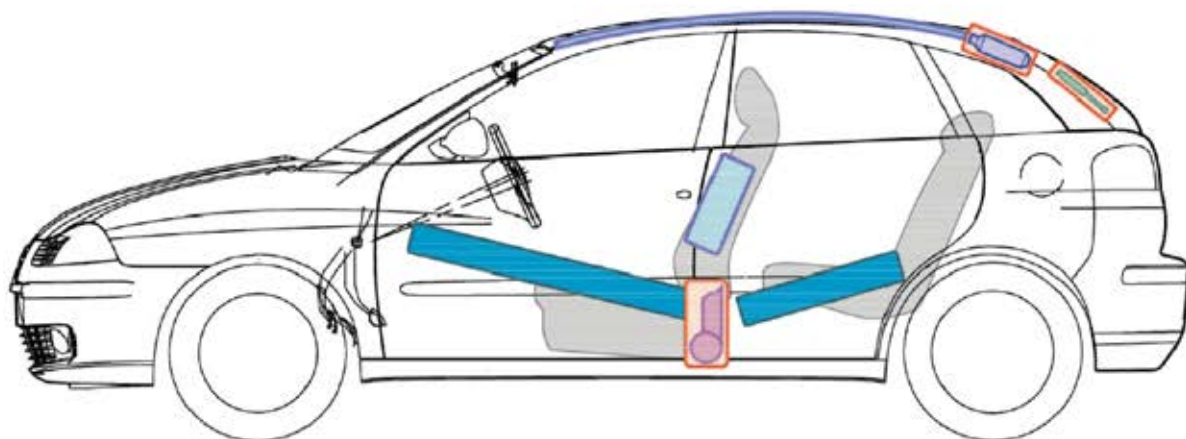
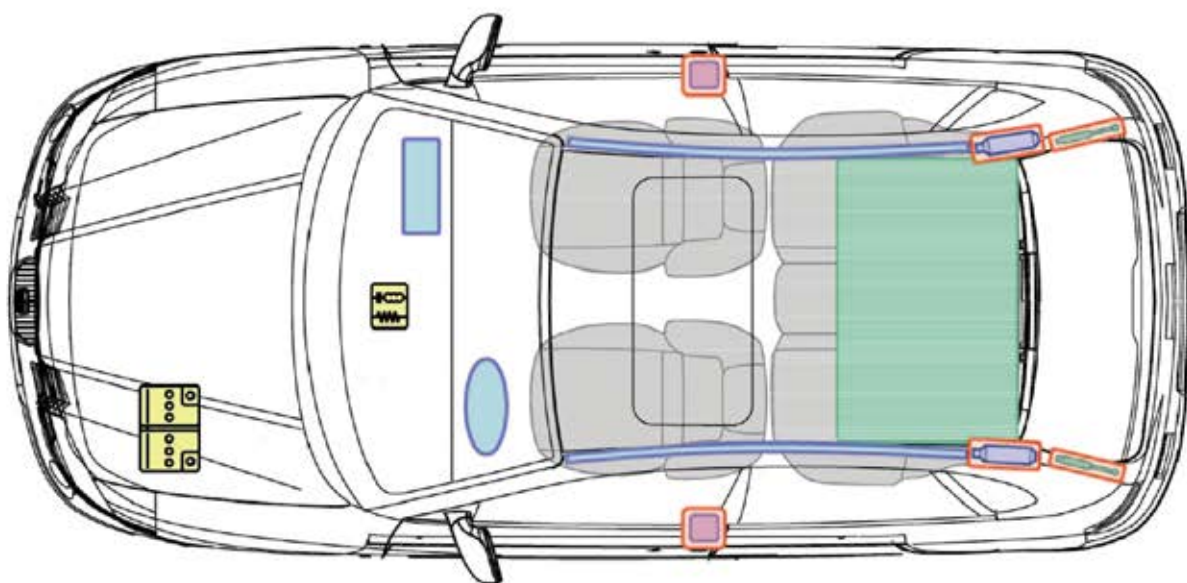

Ibiza (3 - dveřová)

Ibiza

(5 - dveřová, 2002–2009)



Legenda

	airbag		zesílení karoserie		řídící jednotka pro airbag
	plynový generátor		ochrana proti převrácení		baterie
	napínač bezpečnostních pásů		plyno-kapalinové vzpěry		nádrž na pohonné hmoty

Ibiza (5 - dveřová)

Ibiza

(5 - dveřová, od 2016)

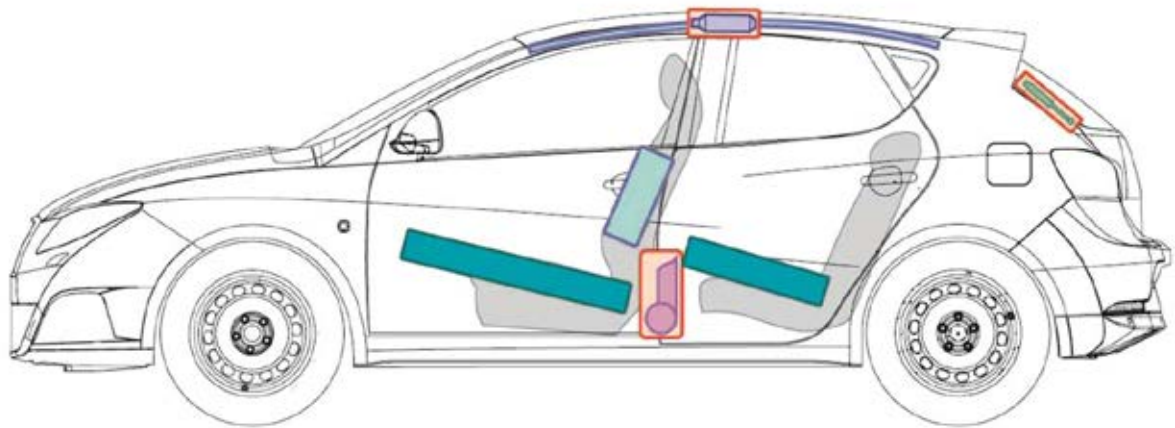
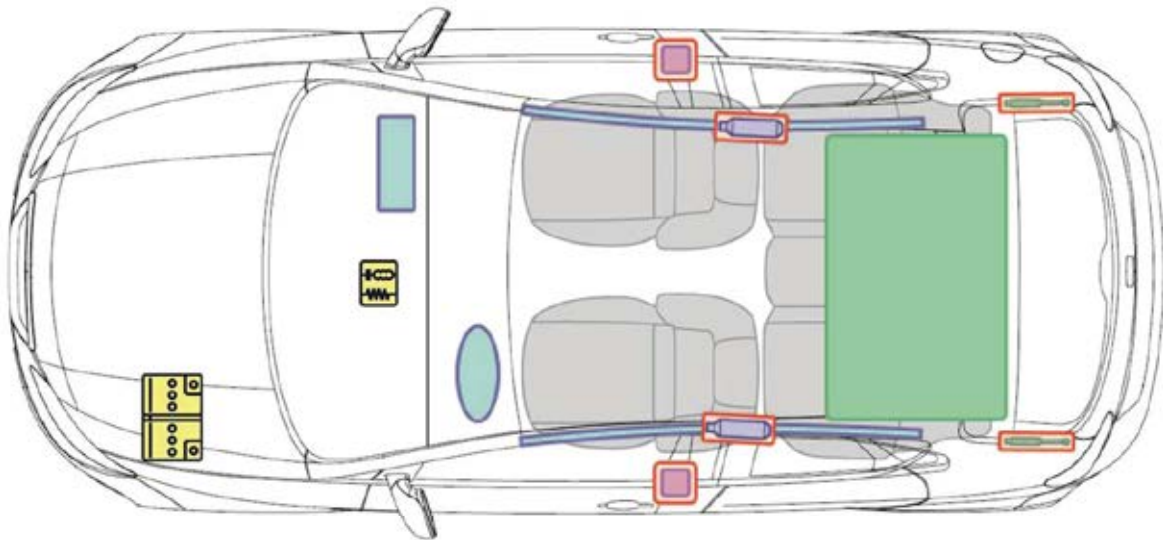

Legenda

	airbag		zesílení karoserie		řídící jednotka pro airbag
	plynový generátor		ochrana proti převrácení		baterie
	napínač bezpečnostních pásů		plyno-kapalinové vzpěry		nádrž na pohonné hmoty

Ibiza (5 - dveřová)

Ibiza

(BiFuel, 5 - dveřová, od 2012)

Motor CNKA 1,6L (LPG)

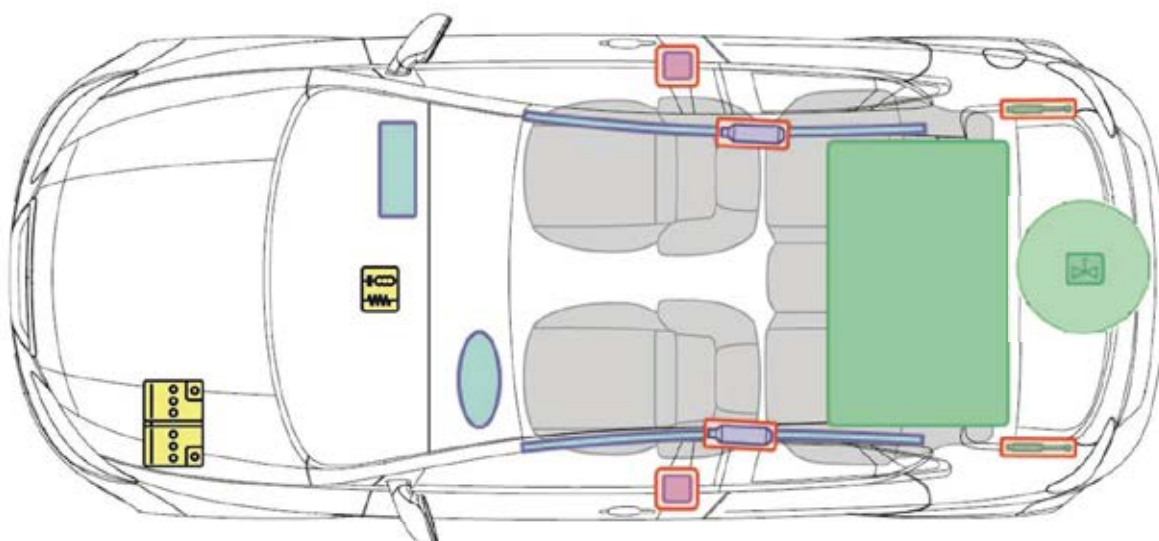

BI FUEL

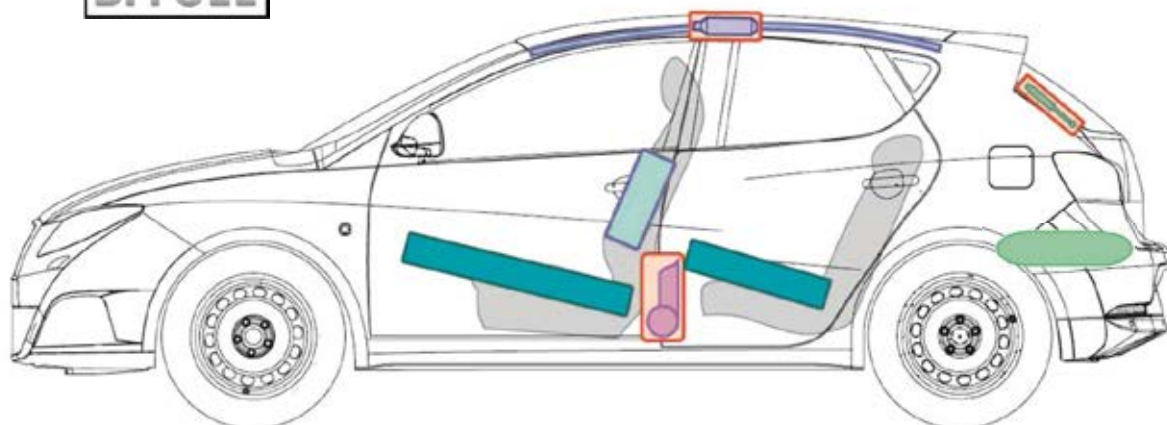

Legenda

	airbag		zesílení karoserie		řídící jednotka pro airbag
	plynový generátor		ochrana proti převrácení		baterie
	napínač bezpečnostních pásů		plyno-kapalinové vzpěry		nádrž na pohonné hmoty
	plynová nádrž		bezpečnostní ventil		





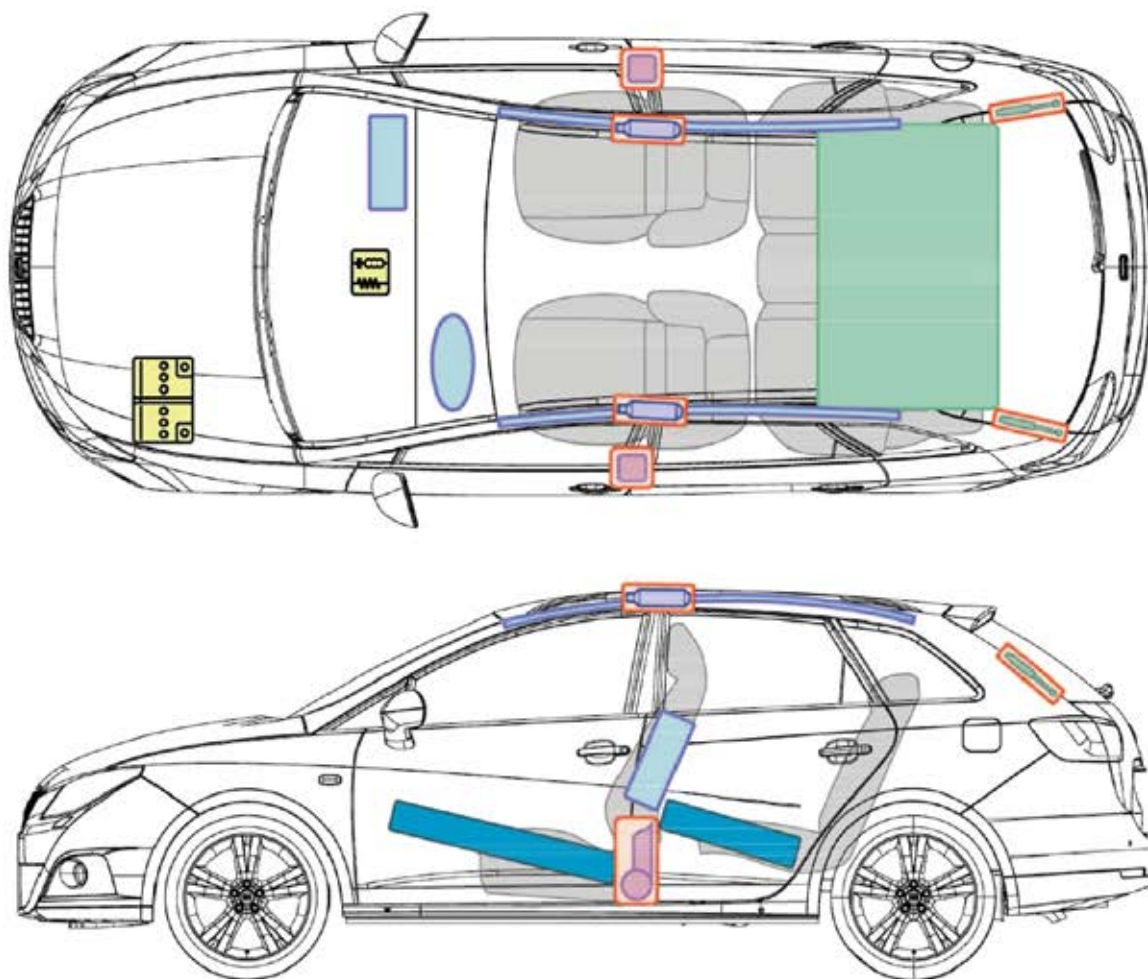



Ibiza ST

(od 2011–2015)

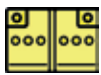

Ibiza ST

Legenda

	airbag		zesílení karoserie		řídící jednotka pro airbag
	plynový generátor		ochrana proti převrácení		baterie
	napínač bezpečnostních pásů		plyno-kapalinové vzpěry		nádrž na pohonné hmoty

Ibiza ST (od 2016)

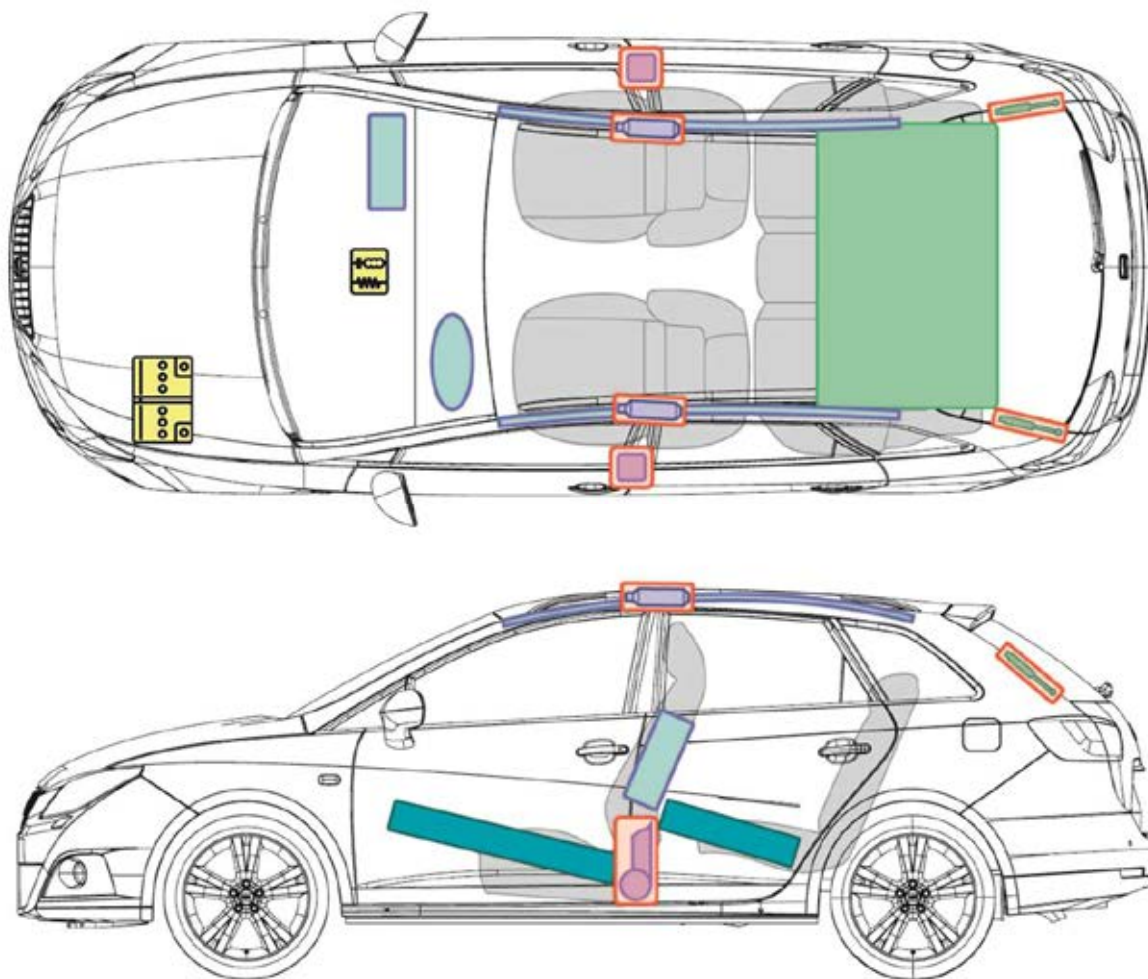

Ibiza ST

Legenda

	airbag		zesílení karoserie		řídící jednotka pro airbag
	plynový generátor		ochrana proti převrácení		baterie
	napínač bezpečnostních pásů		plyno-kapalinové vzpěry		nádrž na pohonné hmoty





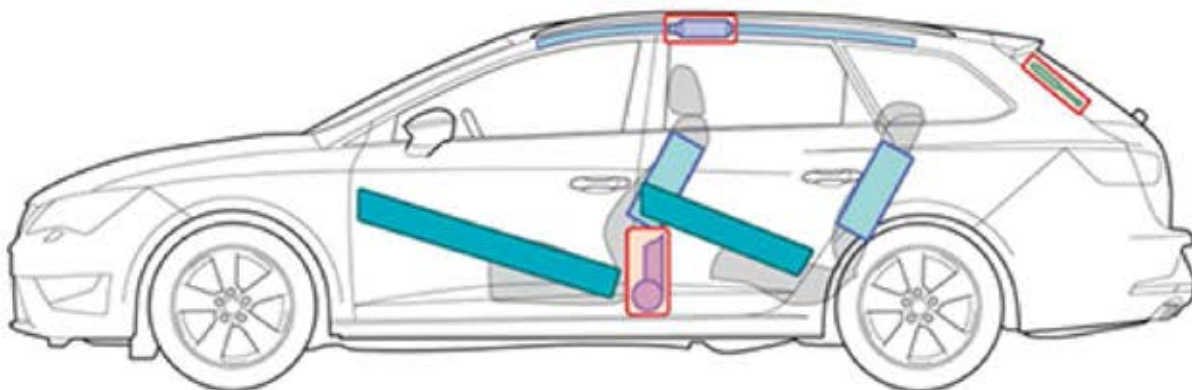
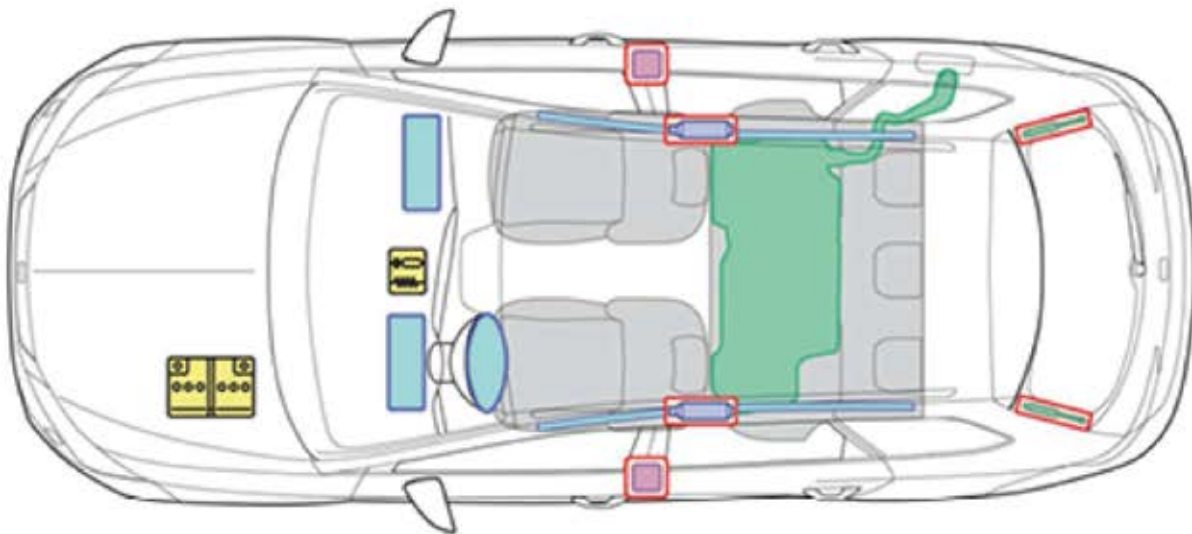



Leon ST

(od 2014)



Leon ST

Legenda





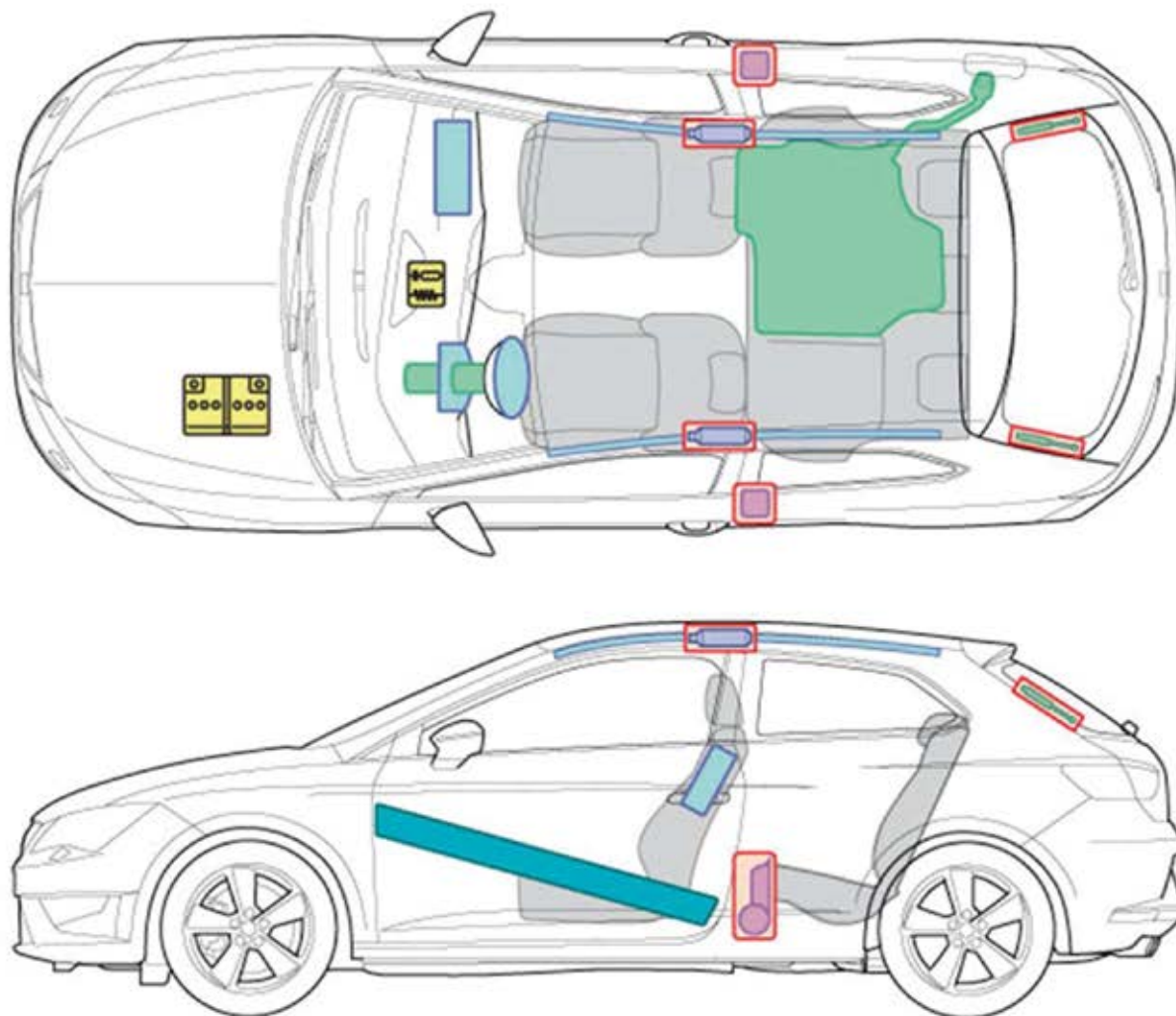

	airbag		zesílení karoserie		řídící jednotka pro airbag
	plynový generátor		ochrana proti převrácení		baterie
	napínač bezpečnostních pásů		plyno-kapalinové vzpěry		nádrž na pohonné hmoty

Leon

(3 - dveřový, od 2013)



Legenda

	airbag		zesílení karoserie		řídící jednotka pro airbag
	plynový generátor		ochrana proti převrácení		baterie
	napínač bezpečnostních pásů		plyno-kapalinové vzpěry		nádrž na pohonné hmoty





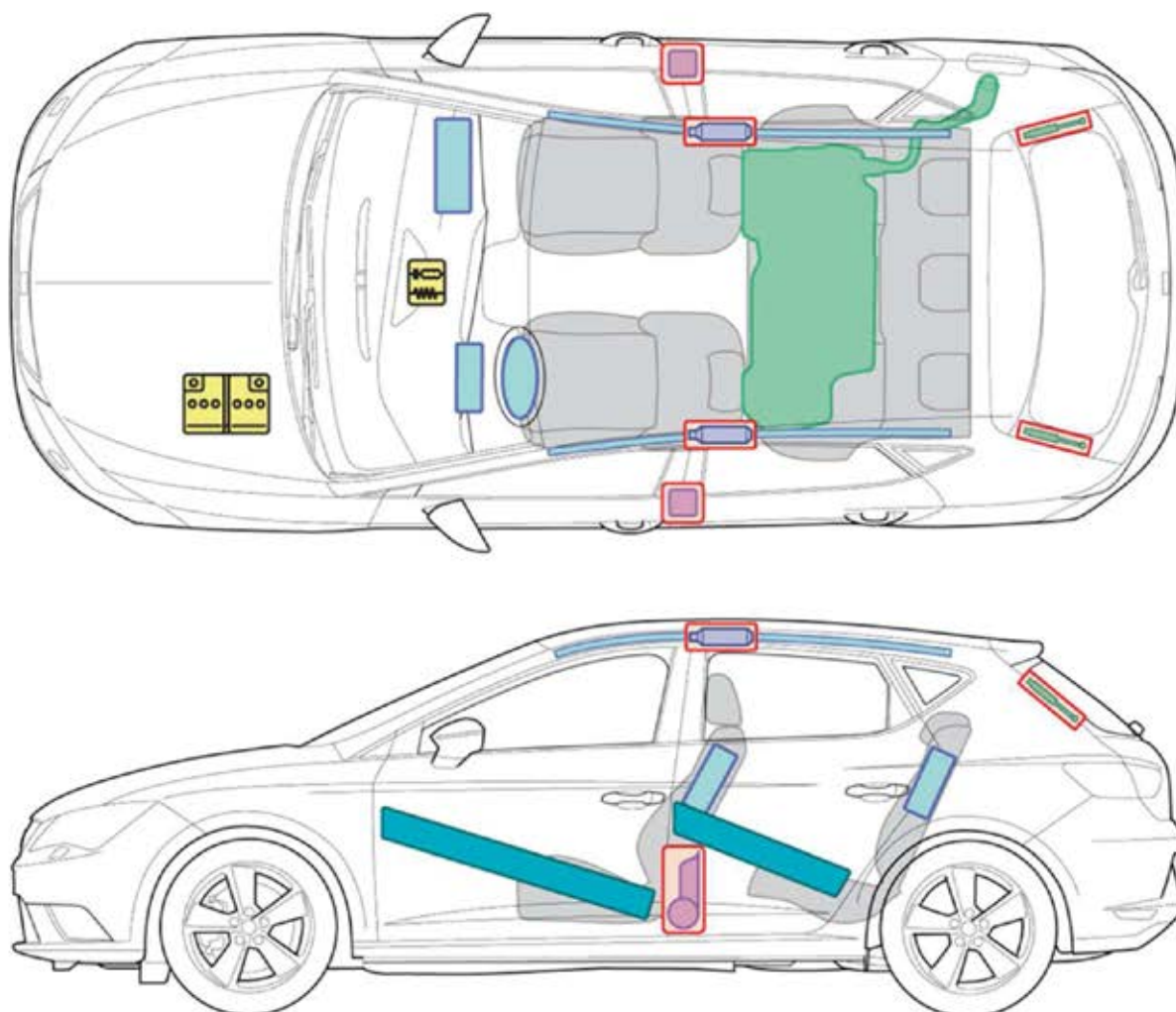

Leon (3 - dveřový)

Leon

(5 - dveřový, od 2013)



Legenda

	airbag		zesílení karoserie		řídící jednotka pro airbag
	plynový generátor		ochrana proti převrácení		baterie
	napínač bezpečnostních pásů		plyno-kapalinové vzpěry		nádrž na pohonné hmoty



Leon (5 - dveřový)

Leon

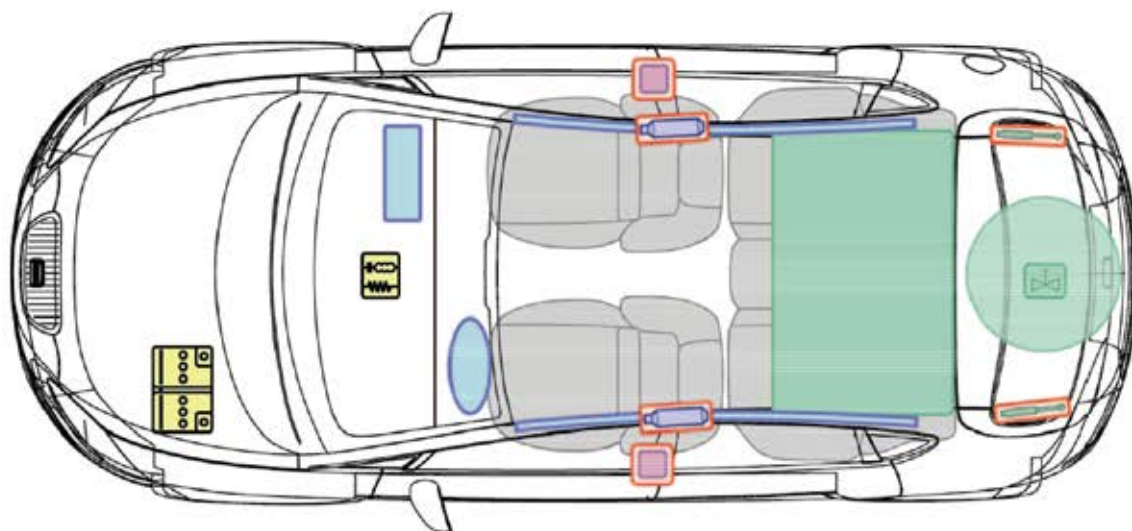

(BiFuel, od 2009)

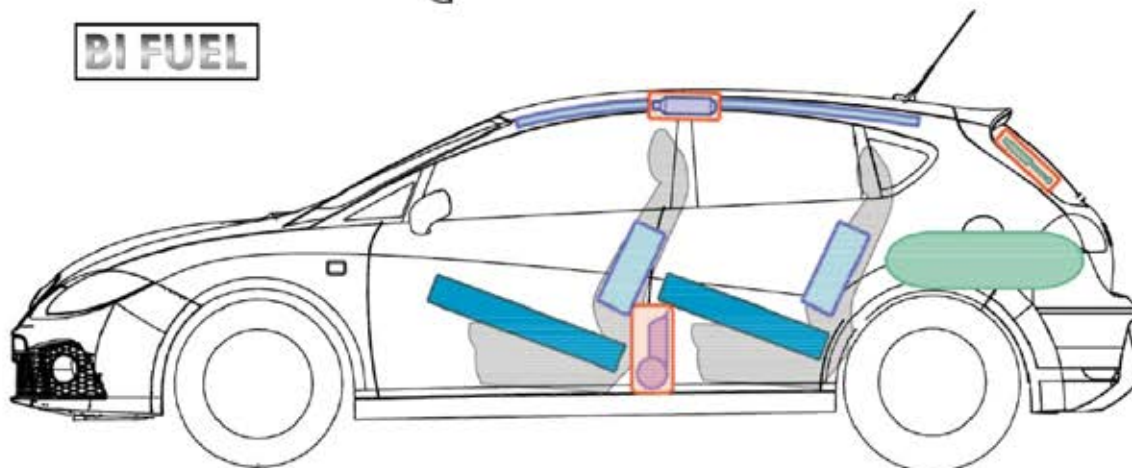

BI FUEL



Legenda

	airbag		zesílení karoserie		řídící jednotka pro airbag
	plynový generátor		ochrana proti převrácení		baterie
	napínač bezpečnostních pásů		plyno-kapalinové vzpěry		nádrž na pohonné hmoty
	plynová nádrž		bezpečnostní ventil		



Leon (BiFuel)





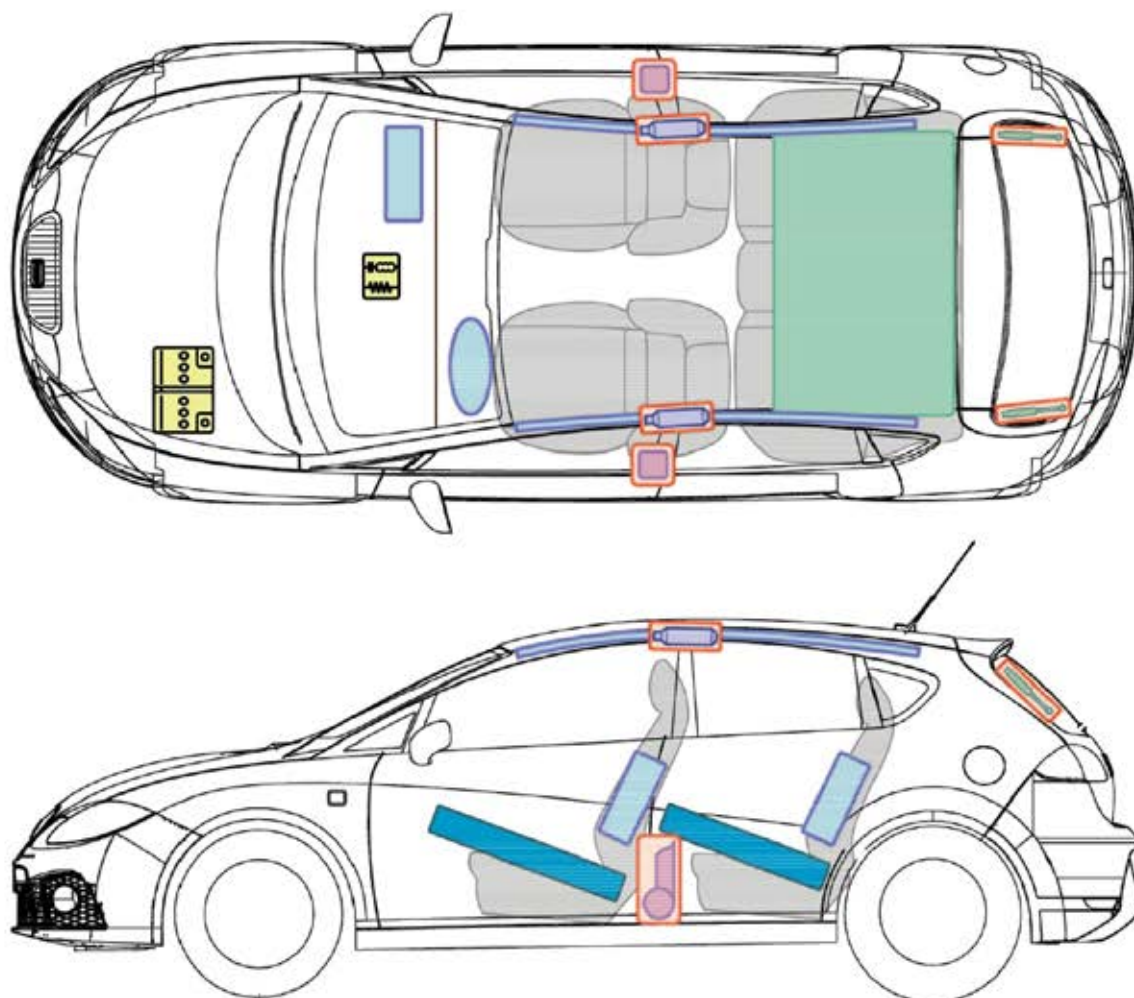



Leon

(od 2006)



Leon

Legenda

 airbag	 zesílení karoserie	 řídicí jednotka pro airbag
 plynový generátor	 ochrana proti převrácení	 baterie
 napínač bezpečnostních pásů	 plyno-kapalinové vzpěry	 nádrž na pohonné hmoty





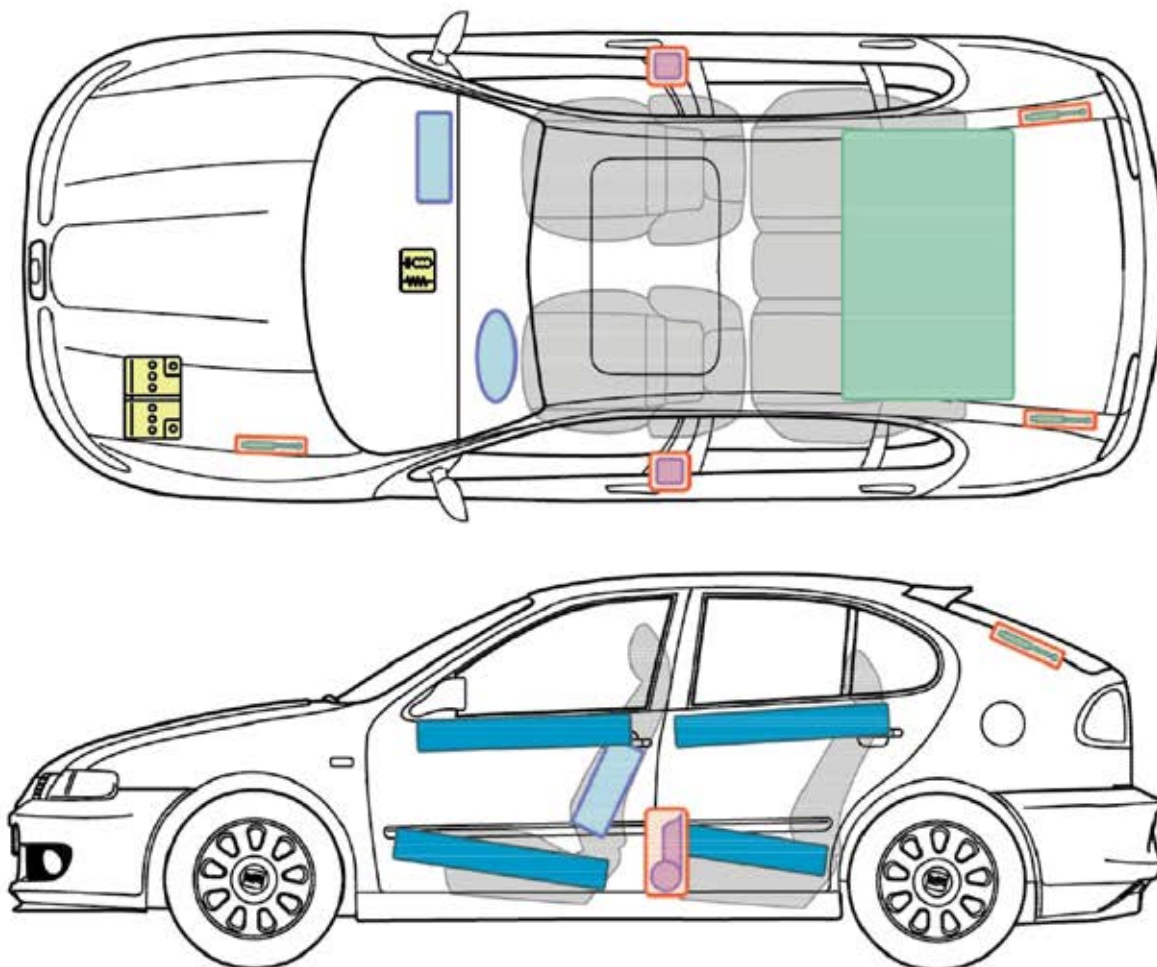



Leon

(1999–2006)

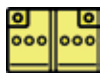

Leon

Legenda

	airbag		zesílení karoserie		řídící jednotka pro airbag
	plynový generátor		ochrana proti převrácení		baterie
	napínač bezpečnostních pásů		plyno-kapalinové vzpěry		nádrž na pohonné hmoty

Leon

(5 - dveřový, TGI, od 2013)

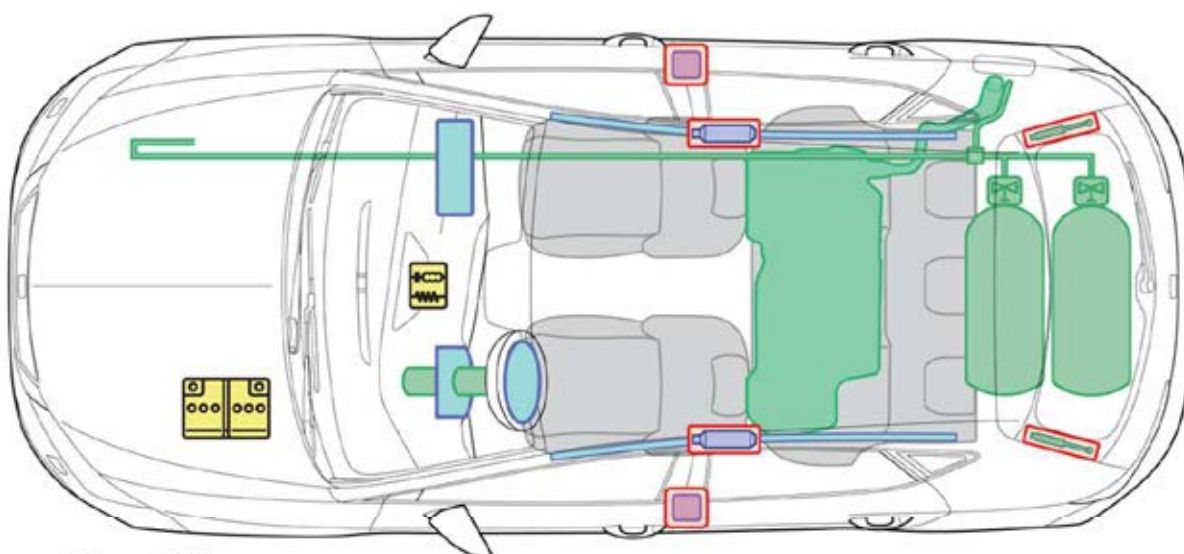

Erdgasantrieb

TGI

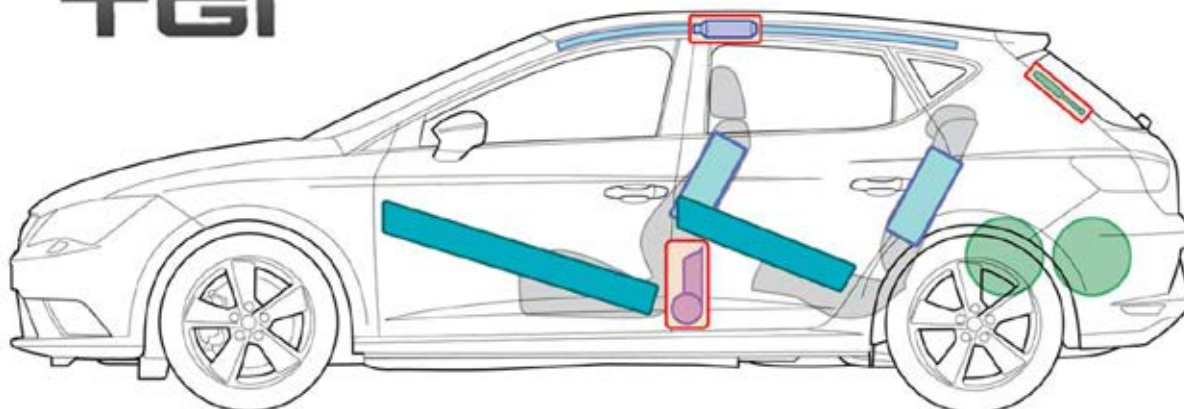

Legenda

	airbag		zesílení karoserie		řídící jednotka pro airbag
	plynová nádrž (CNG)		bezpečnostní ventil		baterie
	napínač bezpečnostních pásů		plyno-kapalinové vzpěry		nádrž na pohonné hmoty

Leon (5 - dveřový, TGI)



Pokyny k pohonu na zemní plyn

Ruční uzavření plynové nádrže

(při zápachu nebo úniku zemního plynu)

1. Přístup k nádržím na zemní plyn

- Přístup k nádržím je ze spodku vozidla.
- Plynové nádrže jsou kryté plastovým obložením. Pro přístup k nádržím je nutné toto obložení odstranit vhodnými prostředky bez poškození pod ním uložených součástí plynového zařízení.

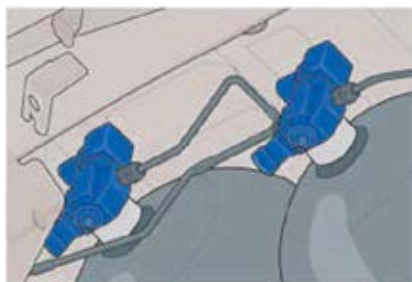

elektromagnetické uzavírací ventily na plynových nádržích

2. Lokalizujte uzavírací kohouty

- Každá plynová nádrž je vybavená vlastním ventilem s ručním uzavíracím kohoutem.
- Pokud to akce vyžaduje, musí se každá plynová nádrž uzavřít samostatně.

3. Ručně uzavřete plynovou nádrž

- Pokud to akce vyžaduje, musí se každá plynová nádrž uzavřít samostatně.
- Pomocí pětikového otevřeného nebo očkového klíče lze ruční uzavírací ventil na čtyřhranu uzavřít otáčením po směru hodinových ručiček až na doraz.



ruční uzavírací kohout po straně ventilu nádrže (do r. 2008).

Leon ST (TGI, od 2014)

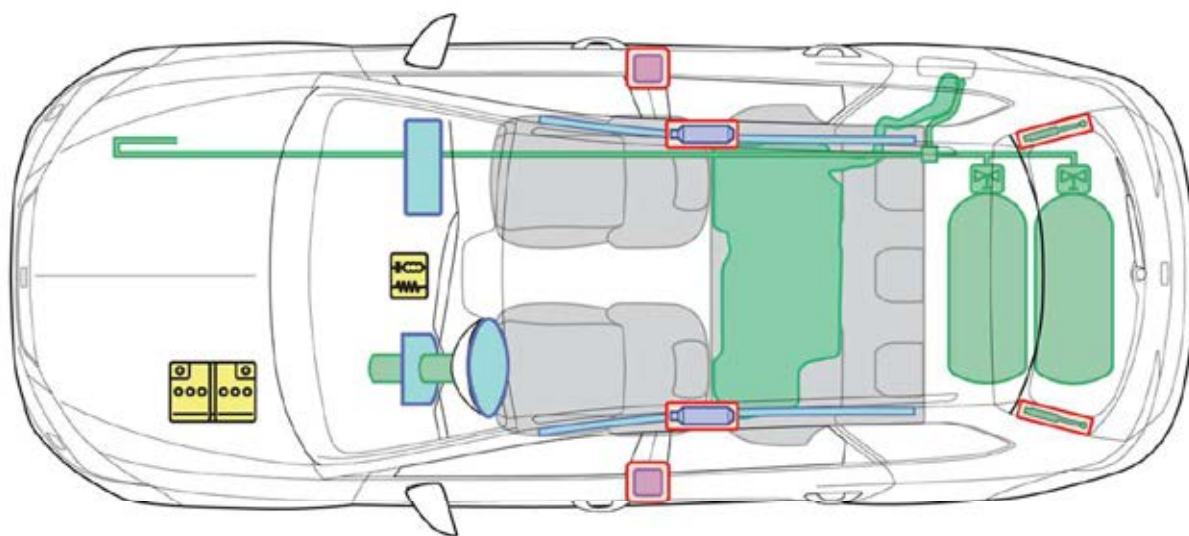

Erdgasantrieb

TGI

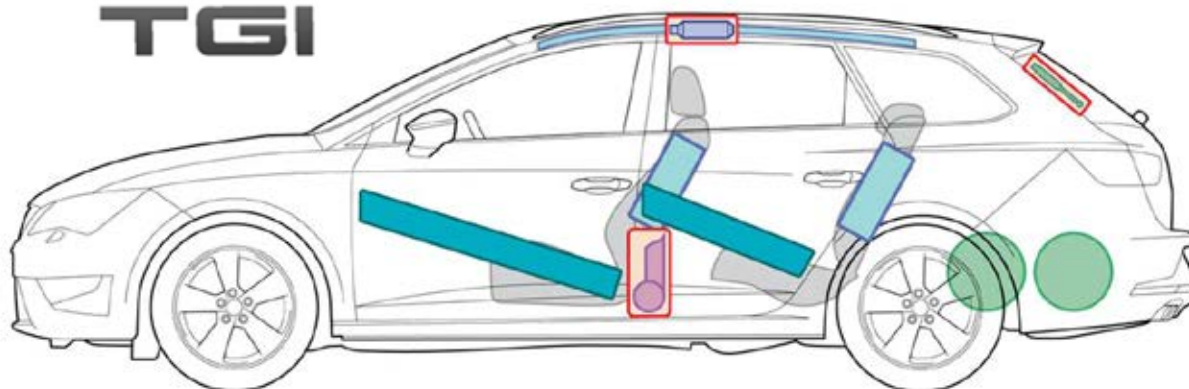

Legenda

	airbag		zesílení karoserie		řídící jednotka pro airbag
	plynová nádrž (CNG)		bezpečnostní ventil		baterie
	napínač bezpečnostních pásů		plyno-kapalinové vzpěry		nádrž na pohonné hmoty

Leon ST (TGI)



Pokyny k pohonu na zemní plyn

Ruční uzavření plynové nádrže

(při zápachu nebo úniku zemního plynu)

1. Přístup k nádržím na zemní plyn

- Přístup k nádržím je ze spodku vozidla.
- Plynové nádrže jsou kryté plastovým obložením. Pro přístup k nádržím je nutné toto obložení odstranit vhodnými prostředky bez poškození pod ním uložených součástí plynového zařízení.

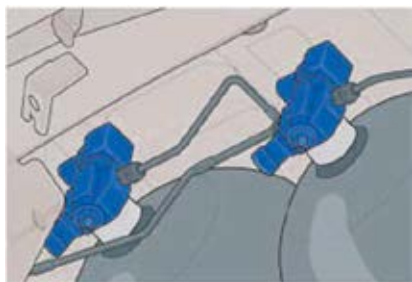

elektromagnetické uzavírací ventily
na plynových nádržích

2. Lokalizujte uzavírací kohouty

- Každá plynová nádrž je vybavená vlastním ventilem s ručním uzavíracím kohoutem.
- Pokud to akce vyžaduje, musí se každá plynová nádrž uzavřít samostatně.



ruční uzavírací kohout po straně
ventilu nádrže (do r. 2008).

3. Ručně uzavřete plynovou nádrž

- Pokud to akce vyžaduje, musí se každá plynová nádrž uzavřít samostatně.
- Pomocí pětikového otevřeného nebo očkového klíče lze ruční uzavírací ventil na čtyřhranu uzavřít otáčením po směru hodinových ručiček až na doraz.

Leon ST Xperience (od 2014)

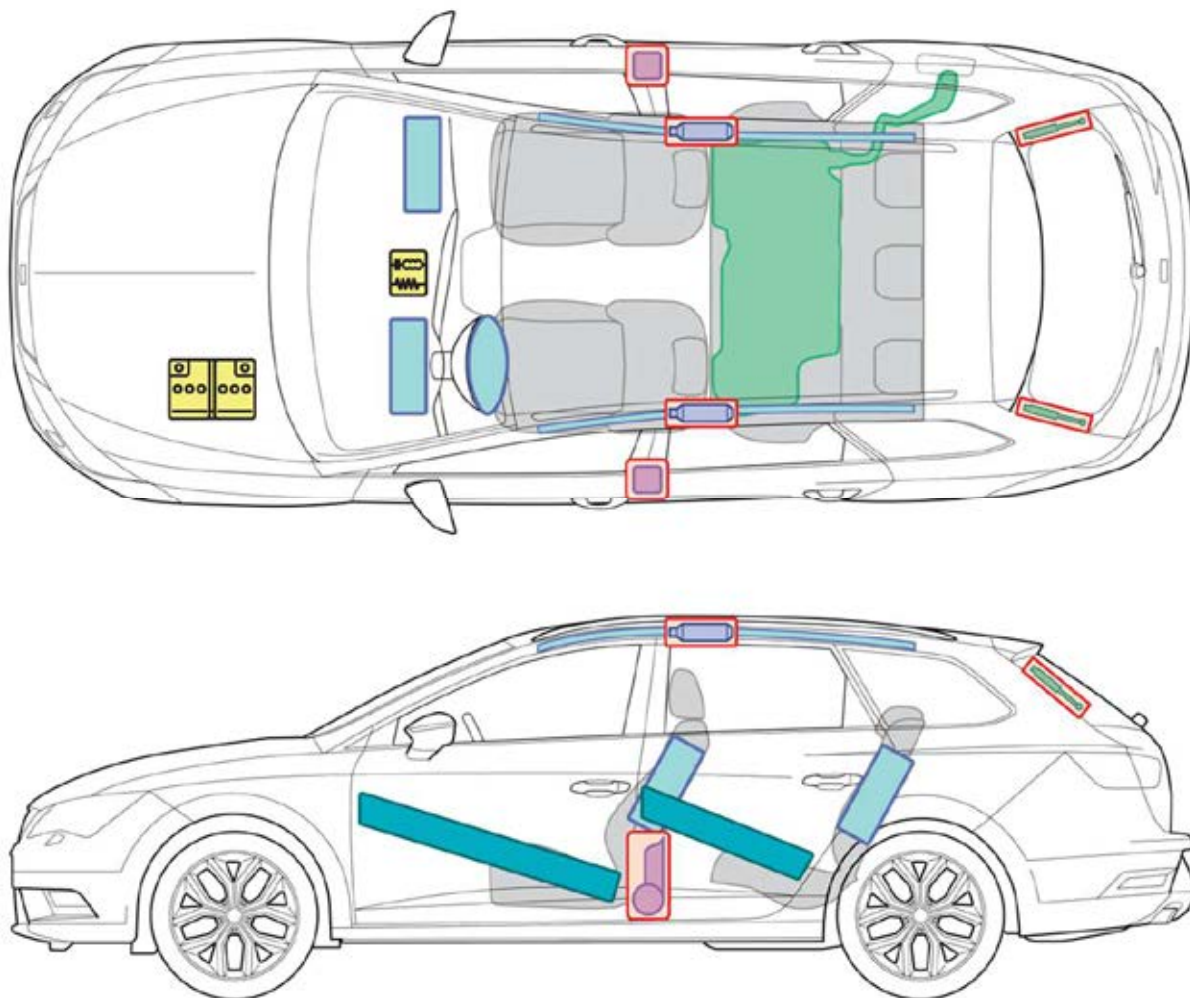

Legenda

 airbag	 zesílení karoserie	 řídicí jednotka pro airbag
 plynový generátor	 ochrana proti převrácení	 baterie
 napínač bezpečnostních pásů	 plyno-kapalinové vzpěry	 nádrž na pohonné hmoty







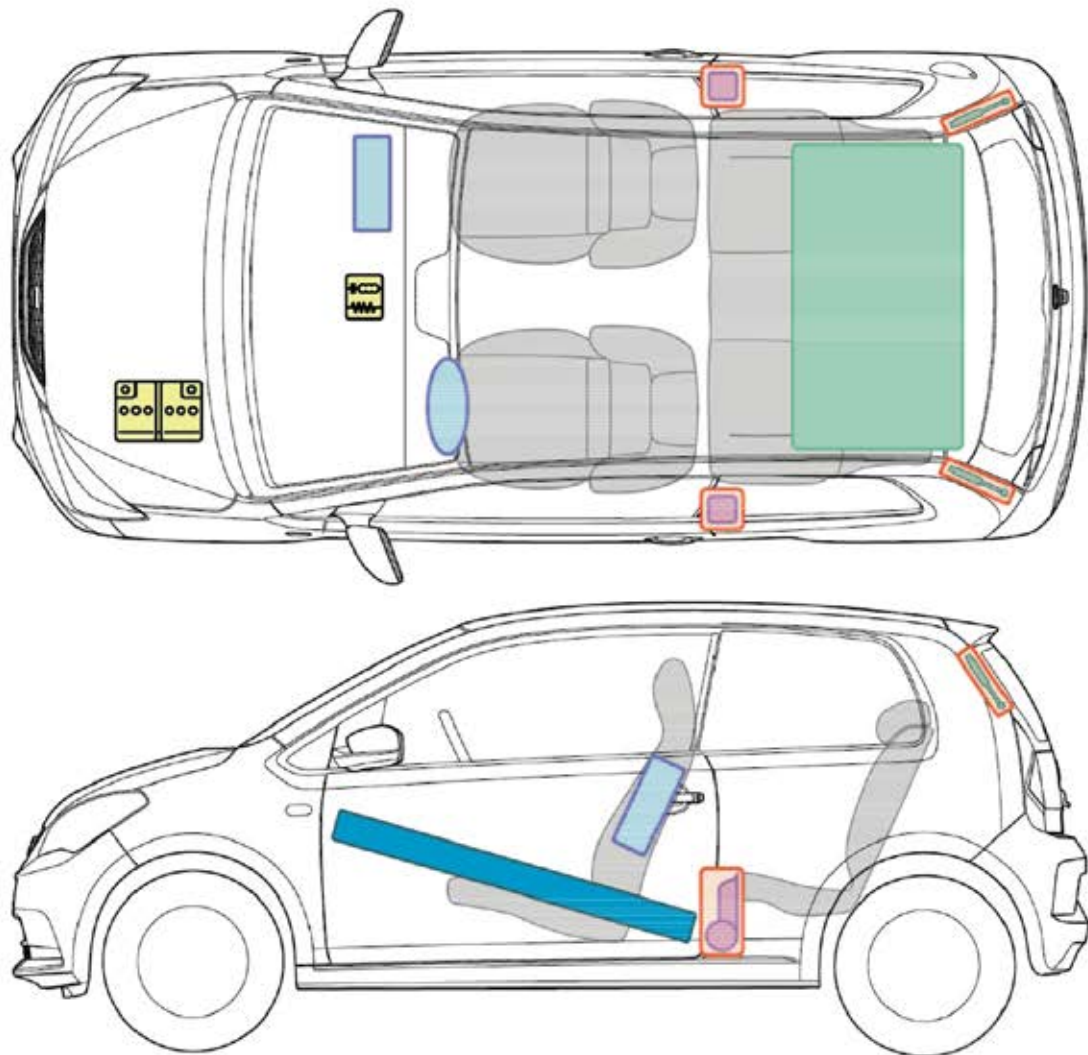

Leon ST Xperience

Mii

(3 - dveřový, od 2012)



Legenda

	airbag		zesílení karoserie		řídící jednotka pro airbag
	plynový generátor		ochrana proti převrácení		baterie
	napínač bezpečnostních pásů		plyno-kapalinové vzpěry		nádrž na pohonné hmoty

M

Mii (3 - dveřový)

Mii

(3 - dveřový, EcoFuel, od 2012)

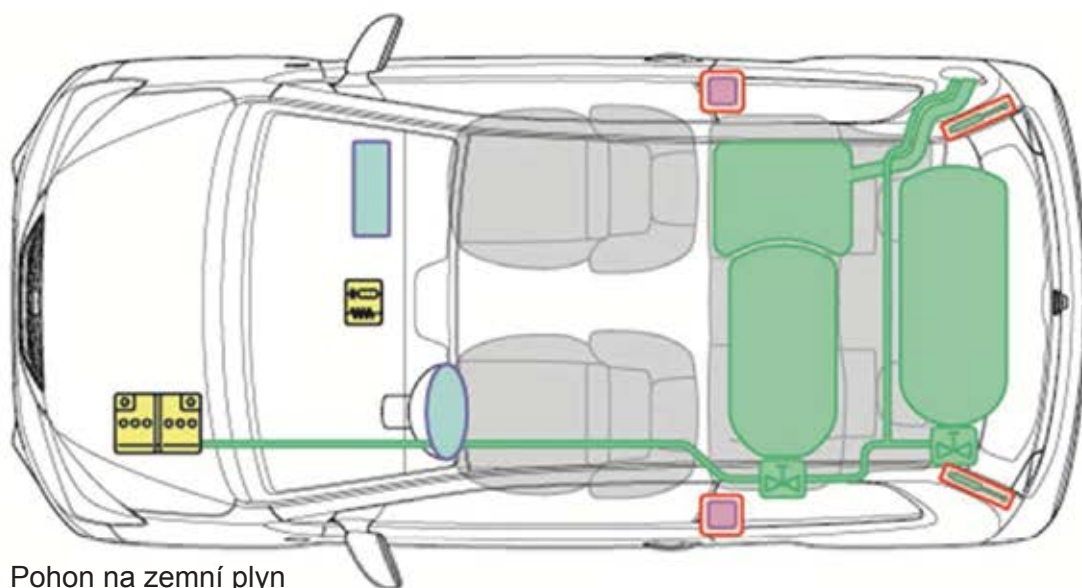

Pohon na zemní plyn

ECO FUEL

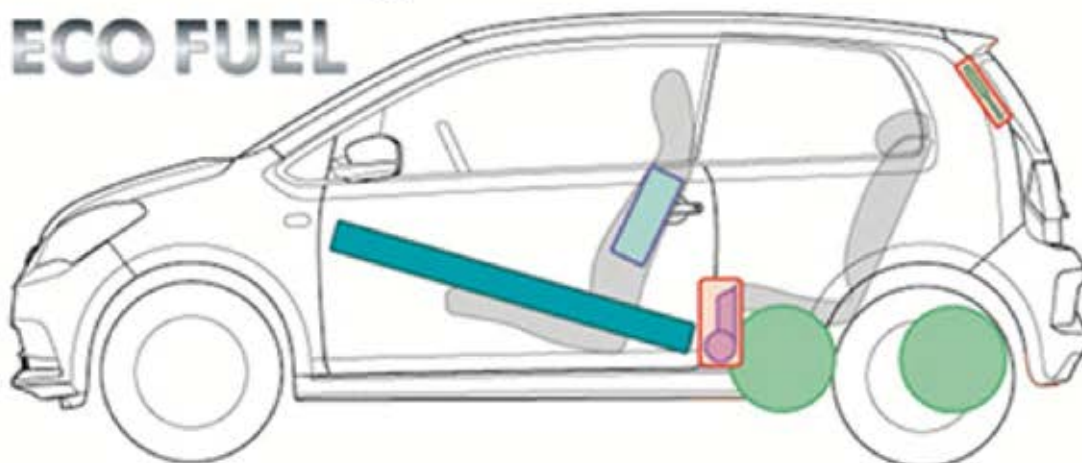

Legenda

	airbag		zesílení karoserie		řídící jednotka pro airbag
	plynová nádrž		bezpečnostní ventil		12V baterie
	napínač bezpečnostních pásů		plyno-kapalinové vzpěry		nádrž na pohonné hmoty

M

Mii (3 - dveřový, EcoFuel)



Pokyny k pohonu na zemní plyn

Ruční uzavření plynové nádrže

(při zápachu nebo úniku zemního plynu)

1. Přístup k nádržím na zemní plyn

- Přístup k nádržím je ze spodku vozidla.
- Plynové nádrže jsou kryté plastovým obložením. Pro přístup k nádržím je nutné toto obložení odstranit vhodnými prostředky bez poškození pod ním uložených součástí plynového zařízení.



elektromagnetické uzavírací ventily
na plynových nádržích

2. Lokalizujte uzavírací kohouty

- Každá plynová nádrž je vybavená vlastním ventilem s ručním uzavíracím kohoutem.
- Pokud to akce vyžaduje, musí se každá plynová nádrž uzavřít samostatně.

3. Ručně uzavřete plynovou nádrž

- Pokud to akce vyžaduje, musí se každá plynová nádrž uzavřít samostatně.
- Pomocí pětikového otevřeného nebo očkového klíče lze ruční uzavírací ventil na čtyřhranu uzavřít otáčením po směru hodinových ručiček až na doraz.



ruční uzavírací kohout po straně
ventilu nádrže (do r. 2008).

Mii

(5 - dveřový, EcoFuel, od 2012)

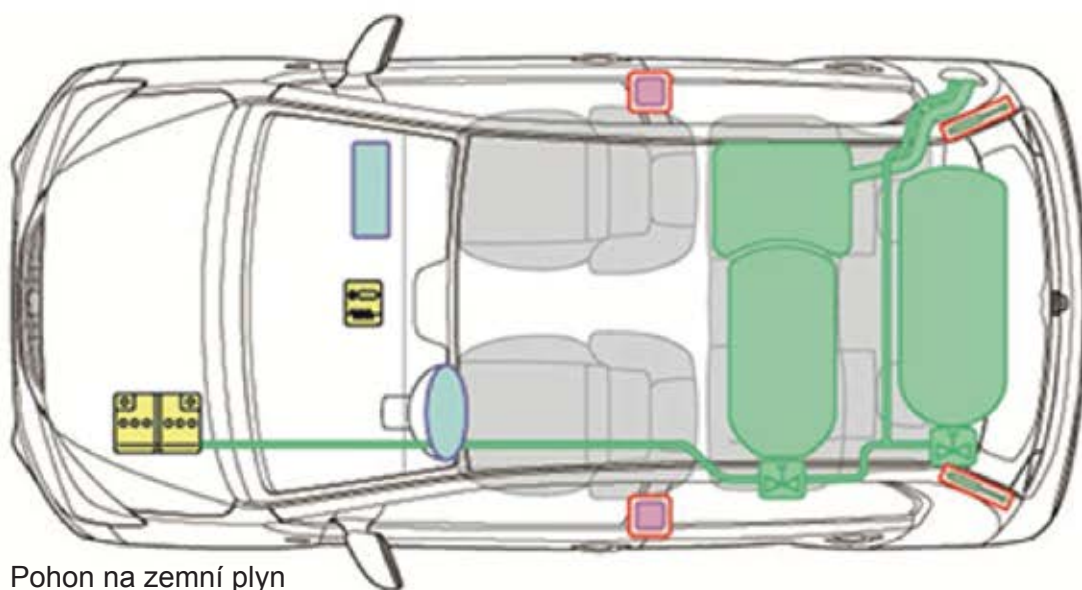

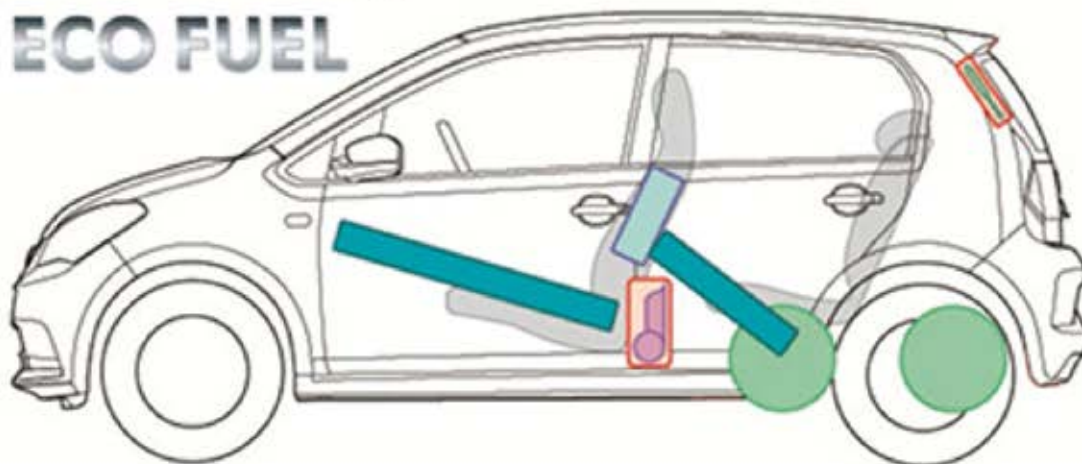

Pohon na zemní plyn

ECO FUEL



Legenda

	airbag		zesílení karoserie		řídící jednotka pro airbag
	plynová nádrž		bezpečnostní ventil		12V baterie
	napínač bezpečnostních pásů		plyno-kapalinové vzpěry		nádrž na pohonné hmoty

M







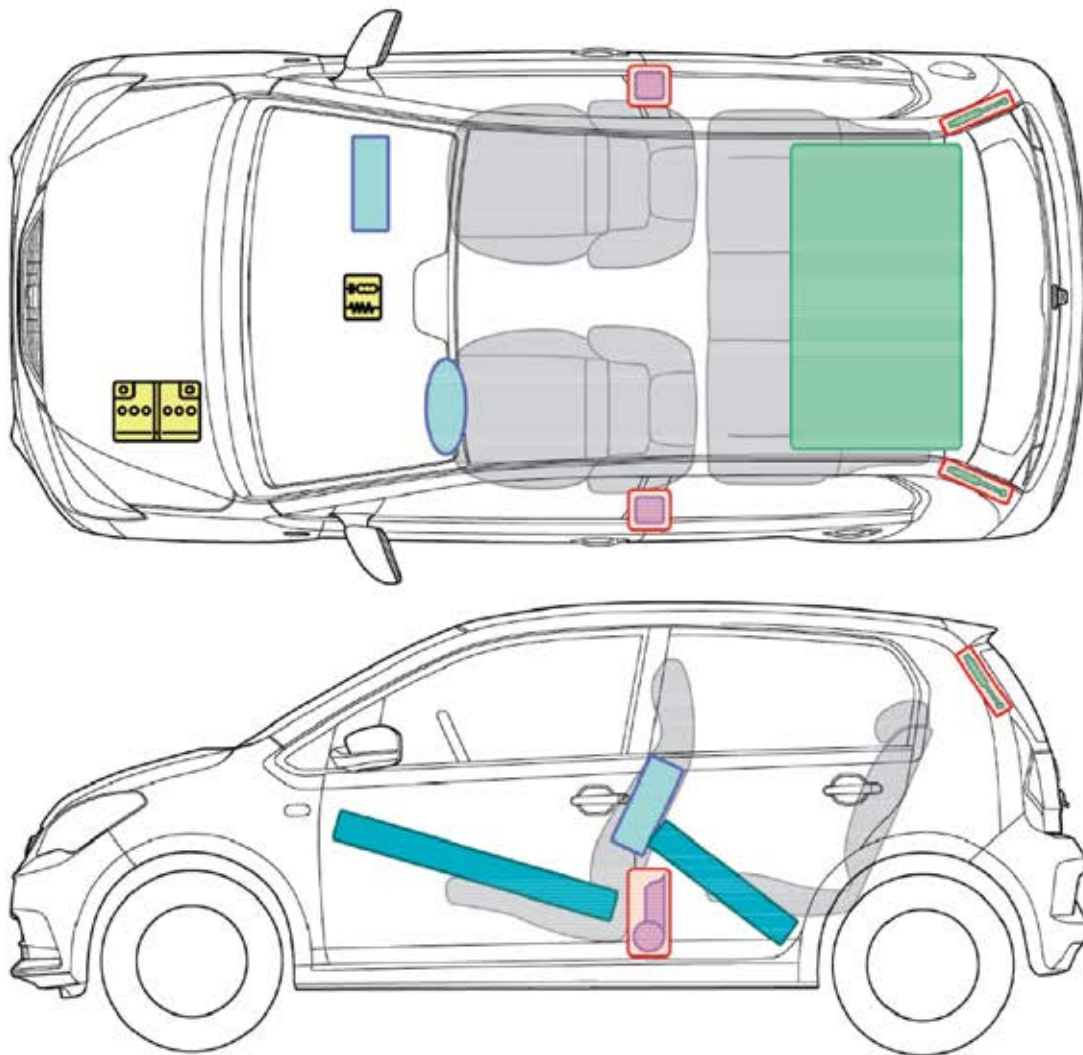

Mii (5 - dveřový, EcoFuel)

Mii

(5 - dveřový, od 2012)

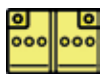

Legenda

	airbag		zesílení karoserie		řídící jednotka pro airbag
	plynový generátor		ochrana proti převrácení		baterie
	napínač bezpečnostních pásů		plyno-kapalinové vzpěry		nádrž na pohonné hmoty

M

Mii (5 - dveřový)



Pokyny k pohonu na zemní plyn

Ruční uzavření plynové nádrže

(při zápachu nebo úniku zemního plynu)

1. Přístup k nádržím na zemní plyn

- Přístup k nádržím je ze spodku vozidla.
- Plynové nádrže jsou kryté plastovým obložením. Pro přístup k nádržím je nutné toto obložení odstranit vhodnými prostředky bez poškození pod ním uložených součástí plynového zařízení.



elektromagnetické uzavírací ventily
na plynových nádržích

2. Lokalizujte uzavírací kohouty

- Každá plynová nádrž je vybavená vlastním ventilem s ručním uzavíracím kohoutem.
- Pokud to akce vyžaduje, musí se každá plynová nádrž uzavřít samostatně.



ruční uzavírací kohout po straně
ventilu nádrže (do r. 2008).

3. Ručně uzavřete plynovou nádrž

- Pokud to akce vyžaduje, musí se každá plynová nádrž uzavřít samostatně.
- Pomocí pětikového otevřeného nebo očkového klíče lze ruční uzavírací ventil na čtyřhranu uzavřít otáčením po směru hodinových ručiček až na doraz.

Toledo



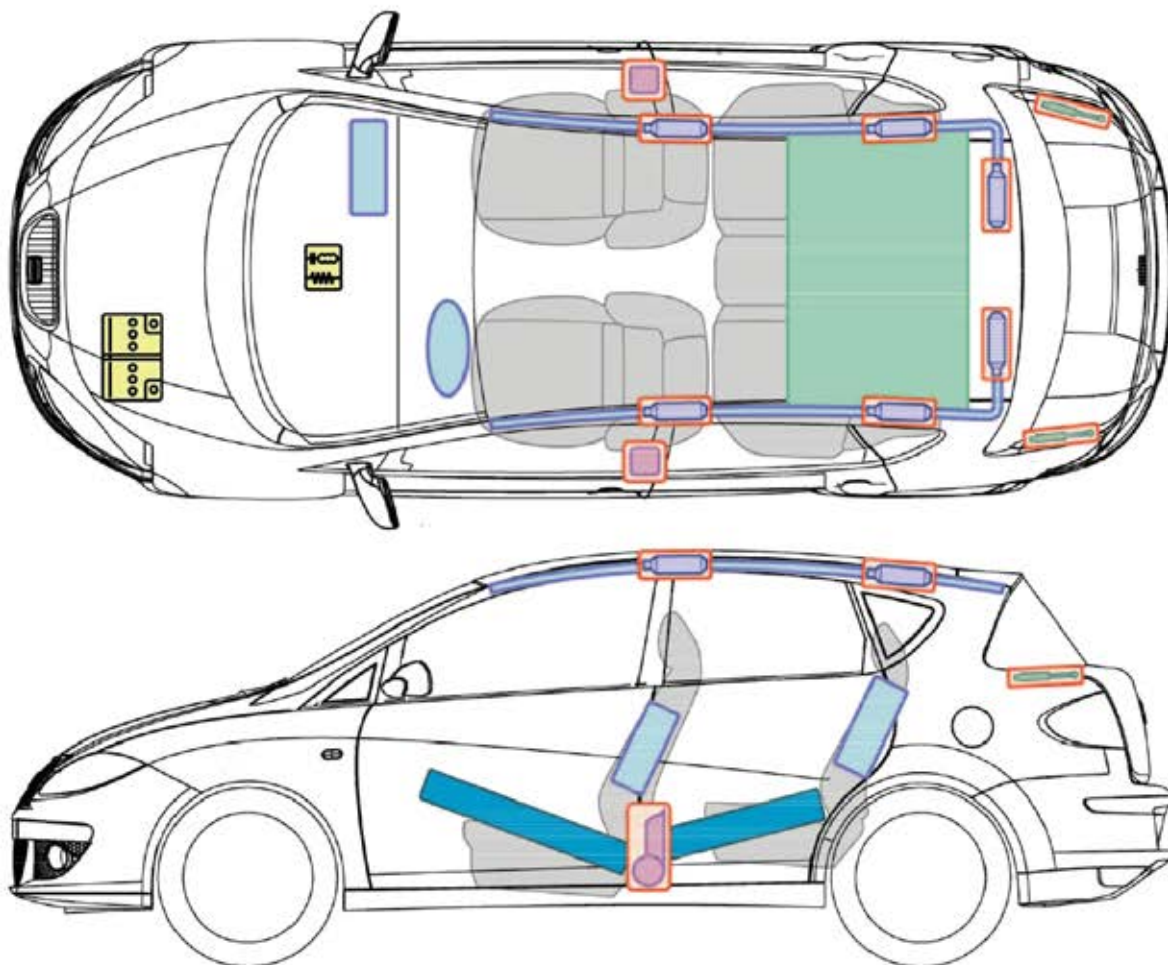





(2005–2009)

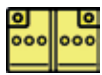

T

Toledo

Legenda

	airbag		zesílení karoserie		řídící jednotka pro airbag
	plynový generátor		ochrana proti převrácení		baterie
	napínač bezpečnostních pásů		plyno-kapalinové vzpěry		nádrž na pohonné hmoty

Toledo



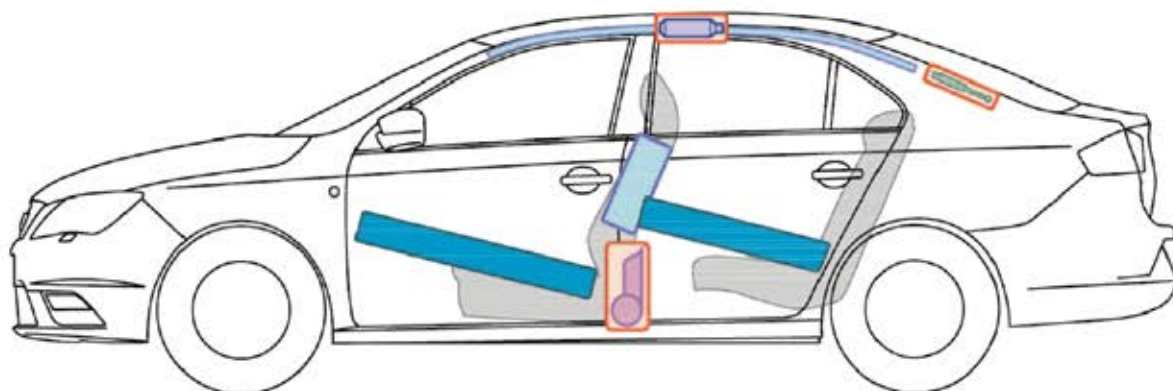
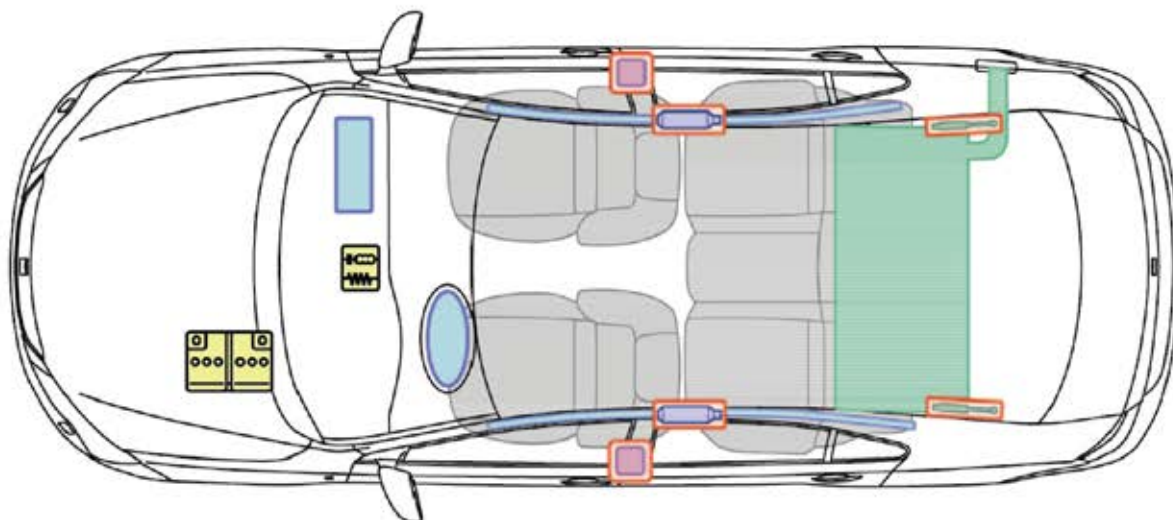





(od 2013)



T

Toledo

Legenda

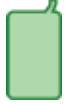
	airbag		zesílení karoserie		řídící jednotka pro airbag
	plynový generátor		ochrana proti převrácení		baterie
	napínač bezpečnostních pásů		plyno-kapalinové vzpěry		nádrž na pohonné hmoty

Toledo



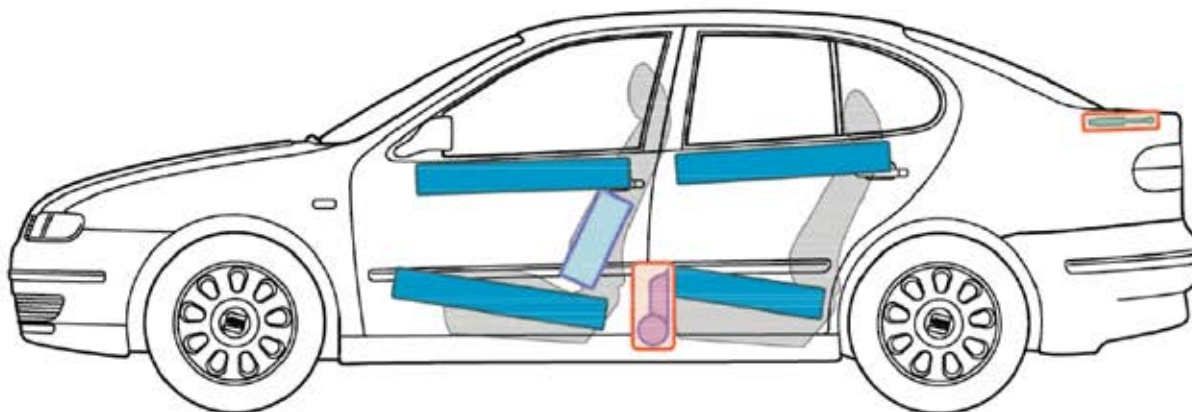
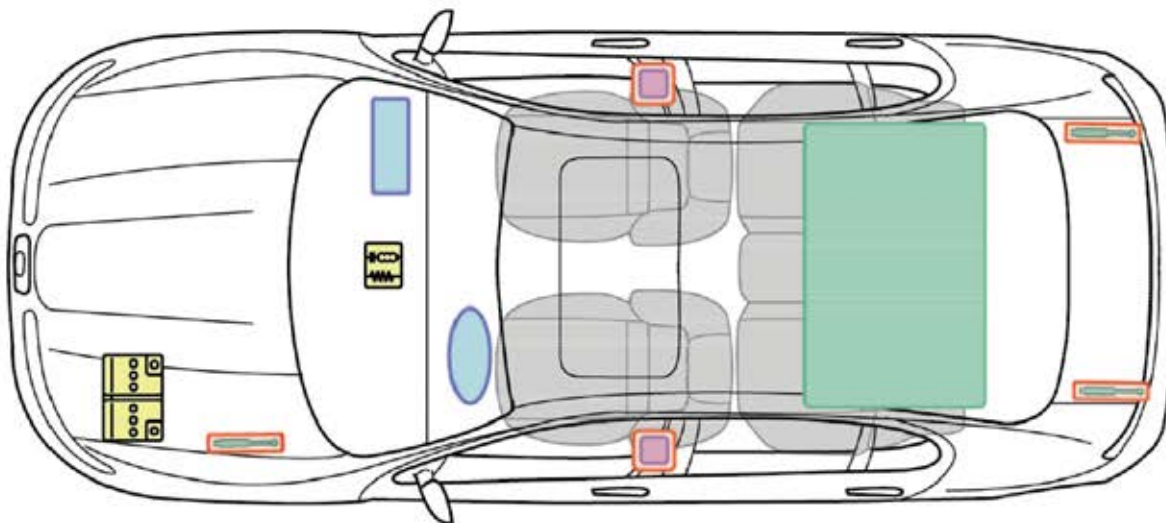





(1999–2004)



T

Toledo

Legenda

 airbag	 zesílení karoserie	 řídicí jednotka pro airbag
 plynový generátor	 ochrana proti převrácení	 baterie
 napínač bezpečnostních pásů	 plyno-kapalinové vzpěry	 nádrž na pohonné hmoty

Toledo

(od 2013)

baterie v zavazadlovém prostoru

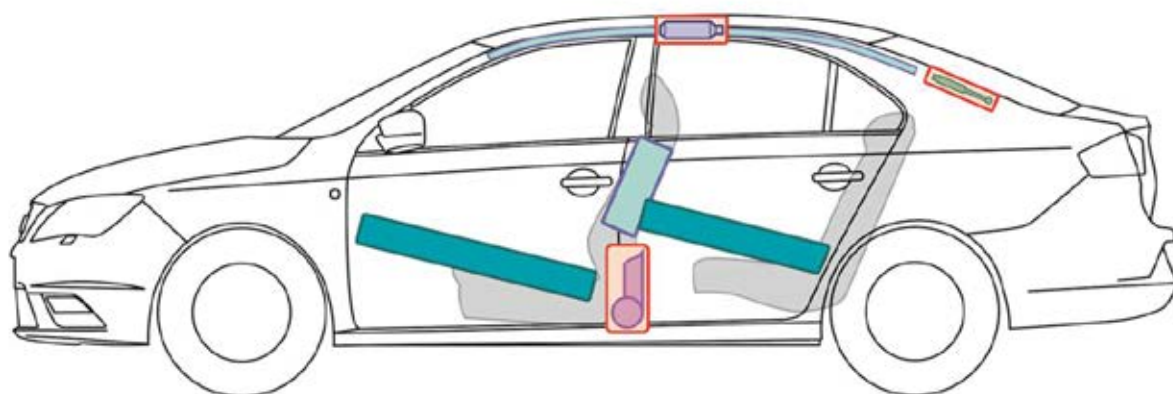
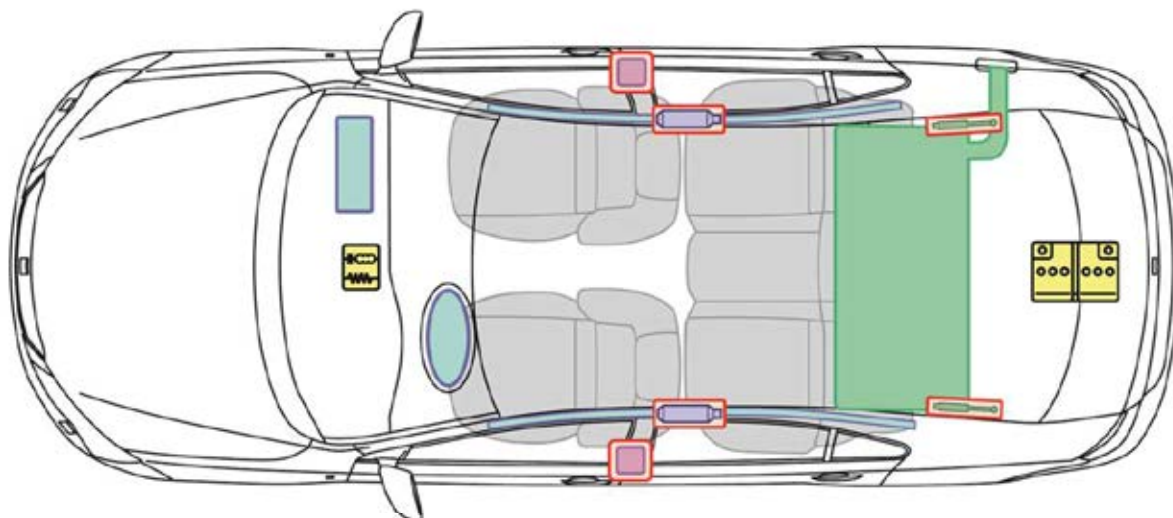

Toledo

Legenda

 airbag	 zesílení karoserie	 řídicí jednotka pro airbag
 plynový generátor	 ochrana proti převrácení	 baterie
 napínač bezpečnostních pásů	 plyno-kapalinové vzpěry	 nádrž na pohonné hmoty

Arona

(ab 2018)

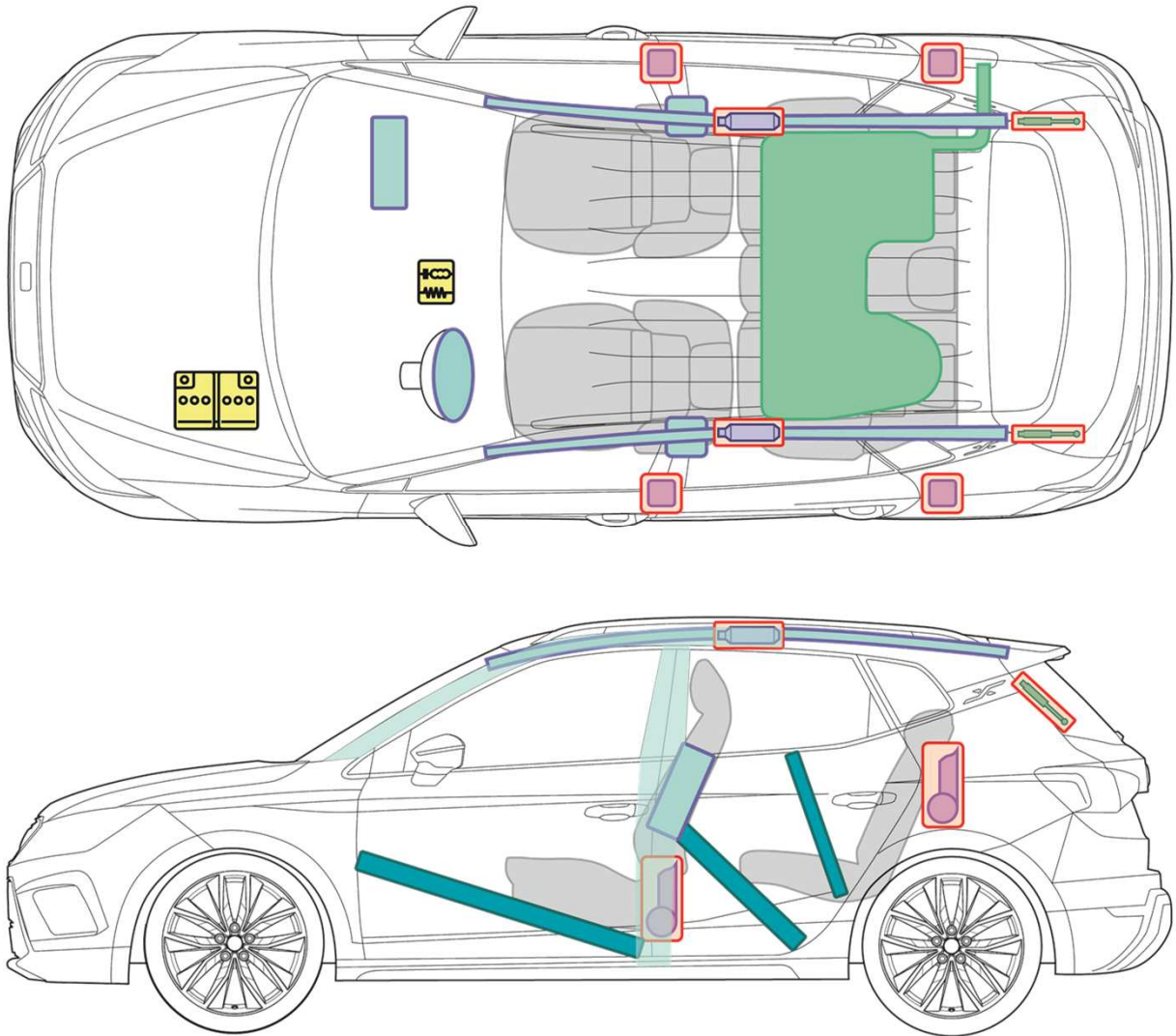

A

Arona

Legende

	Airbag		Karosserie- verstärkung		Steuergerät für Airbag
	Gas generator		Kraftstoff- tank		Batterie
	Gurtstraffer		Gasdruck- dämpfer		